



EHV-S Stackable Lithium Battery

Models 10kWh-15kWh-20kWh



User Manual

This manual describes in detail the requirements and procedures for safe installation and operation of ENSMART lithium battery pack. Please read this manual carefully, only qualified persons are allowed to install, operate and maintain the system, otherwise it may cause product damage or personal safety risks.

Any actions against safety operation, or do not follow rules of this manual and limited warranty letter, will void warranty and qualification of this product. Meanwhile, the manufacturer will be not responsible for the product damage, property damage, personal injury or even death.

The information contained in this manual is accurate when it's issued. ENSMART reserve right to change specification (such as optimization, upgrade or other operations) without prior notice, please always view the latest document via QR code. In addition, please noted that the diagrams/schematics in this document are used to help understand system configuration and installation instructions, which may be different from the actual items at the installation.

Legal Terms

ENSMART will retain the copyright of this document, do not extract, copy or translate in any ways without the written permission.

Version record

Version	Issued date	Updated content	Author
V00		Draft version	
V01		Released version	

Content

- 1. Information** 1
 - 1.1 Validity 1
 - 1.2 Target Group 1
 - 1.3 Levels of warning messages 1
 - 1.4 Symbol Description 2
 - 1.5 Abbreviation Description 3

- 2. Safety** 4
 - 2.1 Safety precautions 4
 - 2.2 Safety instructions 5
 - 2.2.1 Safety gear 5
 - 2.2.2 Emergency safety measures 5
 - 2.2.3 Other Tips 6

- 3. Product Overview** 7
 - 3.1 Introduction 7
 - 3.2 Features 7
 - 3.3 Specification 8
 - 3.3.1 Dimension 8
 - 3.3.2 Parameters 8
 - 3.3.3 Panel Interface 9

- 4. Installation** 12
 - 4.1 Preparation 12
 - 4.1.1 Safety Compliance 12
 - 4.1.2 Environment 12
 - 4.1.3 Tools 13
 - 4.2 Inspection 14
 - 4.2.1 Unpacking 14
 - 4.2.1 Packing list 14

4.3 Start Installation.....	15
4.3.1 Remainder	15
4.3.2 Procedures.....	15
4.4 Installation Steps	15
4.1 Mounting and securing of the base	15
4.2.2 Mounting and securing the battery modules and control module.....	16
5. Cable connection and commissioning.....	17
5.1 Get battery ready	17
5.2 Grounding cable connection	17
5.3 Single battery connection.....	18
5.4 Multi-cluster connection	19
5.4.1 Installation recommended distance	19
5.4.2 Communication port connection	19
5.4.3 Wire the battery cables.....	20
5.5 Turn on the Unit.....	20
5.6 Turn off the Unit.....	20
6. Protective circuit specification	21
7. Troubleshooting Guide and summary.....	22
7.1 Troubleshooting	22
7.2 Key points summary.....	23
8. Transport, Storage.....	24
9. Disposal of battery.....	24

1. Information

1.1 Validity

This document is valid for : EHV-S Series Battery Pack.

1.2 Target Group

This document is intended for qualified persons and operators. Only qualified persons are allowed to perform the activities marked in this document with a warning symbol and the caption "Qualified person". Qualified persons must have the following skills:

- Knowledge of how lithium iron phosphate batteries work and are operated.
- Knowledge of how an energy storage system (including PV/battery/hybrid inverter, MPPT, Meter, Distribution box etc.) works and is operated.
- Knowledge of local applicable connection requirements, standards, and directives.
- Training in the installation and commissioning of electrical devices, batteries.
- Training in how to deal with the dangers and risks associated with installing, repairing and using electrical devices, batteries.

1.3 Levels of warning messages

The following levels of warning messages may occur when handling the product.

DANGER

Indicates a hazardous situation which, if not avoided, will result in death or serious injury.

WARNING

Indicates a hazardous situation which, if not avoided, could result in death or serious injury.

CAUTION











Indicates a hazardous situation which, if not avoided, could result in minor or moderate injury or product permanent damage.

⚠ NOTICE



Indicates a situation which, if not avoided, can result in property damage or product not work or accelerated product damage

1.4 Symbol Description

1.4.1 Symbols on products label

Label	Definition
	Beware of electrical shock.
	Do not place the battery within children/pet touchable area.
	Do not place the battery near heat source and flammable material.
	Do not expose the battery to direct sunlight, rain and snow.
	Do not short circuit the battery.
	The certificate label for Safety by TÜV Rheinland.
	The UL1973 certificate label for Safety by Intertek.
	The certificate label for European EMC directives.
	The certificate label for U.K EMC directives.
	Recycle label.
	WEEE designation.

1.4.2 Other symbols

Label	Definition
 Qualified person	Indicates activities that can only be performed by qualified persons.
	Grounding point.

1.5 Abbreviation Description

Abbreviation	Definition
Battery/battery pack/battery module	Single EHV-S rechargeable lithium iron phosphate battery pack including cells, BMS and enclosure etc.
Battery system/cluster	Multiple EHV-S41050A battery module connected in parallel with power, communication and grounding cables and installation auxiliaries.
BMS	Battery management system Electronical Unit to ensure lithium cells' safety and display information or control the battery work mode.
SOC	State of charge The battery state of charge refers to the percentage of the remaining capacity and rated capacity of the battery.
SOH	State of health The battery health status refers to the percentage between the full charged capacity and the rated capacity of the battery.

2. Safety

2.1 Safety precautions

DANGER

Explosion risk

- Do not impact the battery with heavy objects.
- Do not squeeze or pierce the battery pack.
- Do not throw the battery pack into the fire.

WARNING

Fire risk

- Do not expose the battery pack to the condition over 80°C.
- Do not put the battery near a heat source, such as a fireplace.
- Do not expose the battery pack to direct sunlight or raining.

CAUTION

Electric shock risk

- Do not allow non-qualified person to disassemble the battery pack.
- Do not touch the battery pack with wet hands.
- Do not expose the battery pack to moisture or liquid environment.

NOTICE

Damage risk

- Do not short-circuit or reverse connect the battery.
- Do not use chargers or charging devices unapproved by the manufacturer to charge the battery.
- Do not mix batteries from different manufacturers or different kinds, types or brands.

2.2 Safety instructions

The battery has been designed and tested in accordance with international (such as UL, IEC, UN38.3 etc.) safety requirements. However, due to various factors during the whole lifetime process, ENSMART cannot guarantee absolute safety, in order to prevent personal injury and property damage and ensure long-term operation of the battery, please do read the below section carefully to operate the battery and handle emergency situations.

2.2.1 Safety gear

It is required to wear the following safety gear when installing and handling the battery pack.



Insulated gloves



Safety Glasses



Safety Shoes

2.2.2 Emergency safety measures

Water invasion

Please cut off the AC power supply of the system first and then disconnect all switched under the premise of ensuring safety.

Electrolyte or gas leakage

If the battery pack leaks electrolyte, avoid contact with the leaking liquid or gas. If one is exposed to the leaked substance, immediately perform the actions described below.

- **Gas Inhalation:** Evacuate the people in the contaminated area and seek medical aid immediately.
- **Eye Contact:** Flush your eye with clean and flowing water for 15 min, and seek medical aid immediately.
- **Skin Contact:** Thoroughly rinse the exposed area with soap and water to be sure no chemical or soap is left on them, and seek medical aid immediately.
- **Ingestion:** Induce vomiting, and seek medical help immediately.

WARNING

In case of fire situations, please use carbon dioxide fire extinguisher rather than liquid to put out fires.

2.2.3 Other Tips

- All the product are strictly inspected before shipment, please contact your supplier for replacement if you notice there's any defectives such as swelling.
- Do not disassemble batteries and components, otherwise the manufacturer will not be responsible for any damage caused by unauthorized disassembly or repair.
- Do enable the battery to be safely grounded before use to make sure the system in safe and normal operation.
- Please ensure that the electric parameters of these devices are compatible mutually before connecting the battery to other devices.
- Please take the environmental factors into careful considerations to ensure that the system can work in a suitable condition as the environment and storage methods have a certain impact on the service life and reliability of this product.

3. Product Overview

3.1 Introduction

The EHV-S series battery is designed for residential application and works as a storage unit in the photovoltaic system. It could be operated in both on-grid, back-up and off-grid modes with compatible inverters. Below is the general schematic of an ac-coupled system with the batteries.

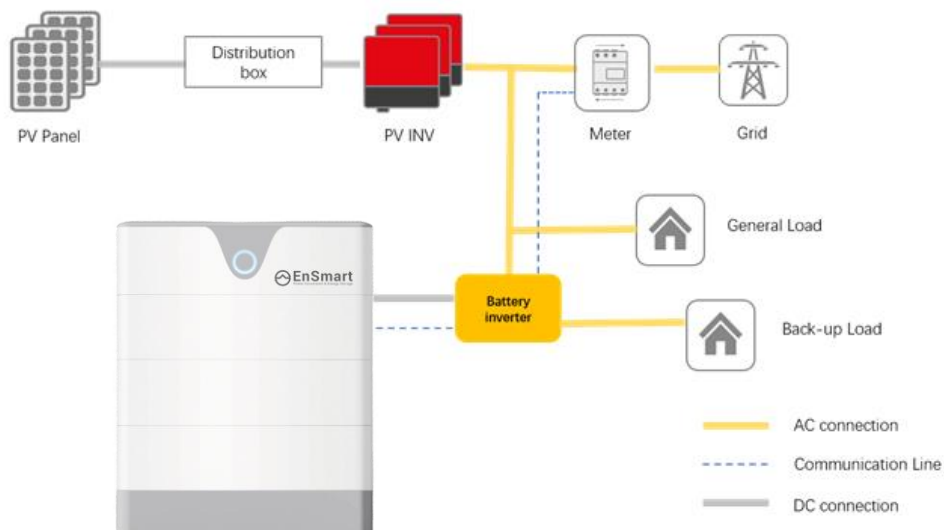

⚠ CAUTION

This electrical connection in this diagram is only for illustration, please follow the Manual suggestions of related devices and operate in accordance with locally applicable connection requirements, standards, and directives.

3.2 Features

- Highest safety, battery is made from LiFePO₄ chemistry and comply with highest international safety and transport standard.
- Modular and flexible, supports up to 8 batteries in parallel connect together to expand the system energy.
- Build-in pre-charge circuit to avoid rush current when connecting with different inverter/chargers.
- Support a maximum of 96% DOD under off-grid and back-up application.

- Built in BMS provide warning and protection functions including over-discharged, over-charged, over-current, short-circuit and high/low temperature.
- LiFePO₄ as cathode material and automatic balancing function to meet longer cycle life.
- Modular design, Compact size and light weight for easy installation and maintenance.
- Multiple installation bracket to adopt with different customers' requirement.
- CAN/RS485 port for external communication and upgrade the BMS firmware.

3.3 Specification

3.3.1 Dimension

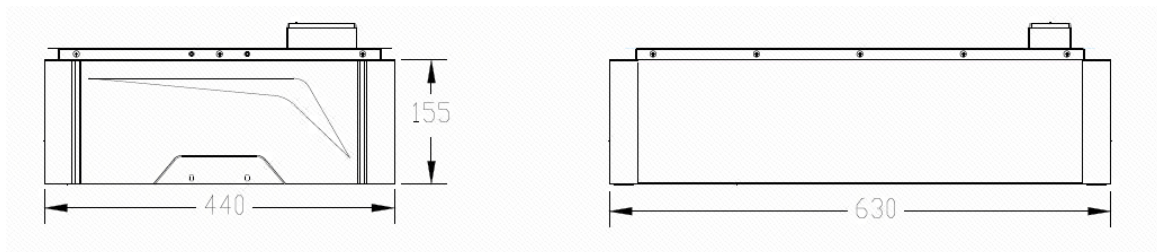

Battery module (unit: mm):

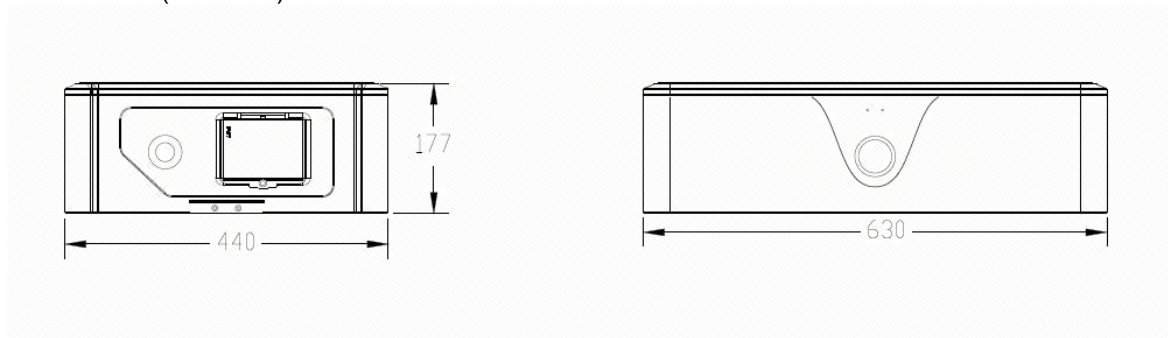

Control module (unit: mm):



3.3.2 Parameters

	EHV-S20550A	EHV-S30750A	EHV-S41050A
Items			
Number of battery	2	3	4
Total energy	10.24kWh	15.36 kWh	20.48 kWh
Nominal voltage	204.8V	307.2V	409.6V
Operation voltage	185.6V~233.6V	278.4V~350.4V	371.2V~467.2V
Nominal capacity	50Ah		
Recommend charge	25A		
Max. charge current	50A		

Max. discharge current	50A		
Charging temperature	0°C~50°C(32~122F)		
Discharging	-10°C~50°C (-14~122F)		
Dimension [W*D*H]	630*440*590 mm	630*440*745 mm	630*440*900 mm
	(24.8*17.3*23.2 inch)	(24.8*17.3*29.3 inch)	(24.8*17.3*35.4 inch)
Weight	≈141kg(310.8lb)	≈199kg (438.7lb)	≈257kg(566.5lb)
Enclosure protection	IP55 (indoor unit)		
Scalability	Up to 8 units in parallel		
Communication to	CAN/RS485		
High Current Circuit	80 A		

3.3.3 Panel Interface

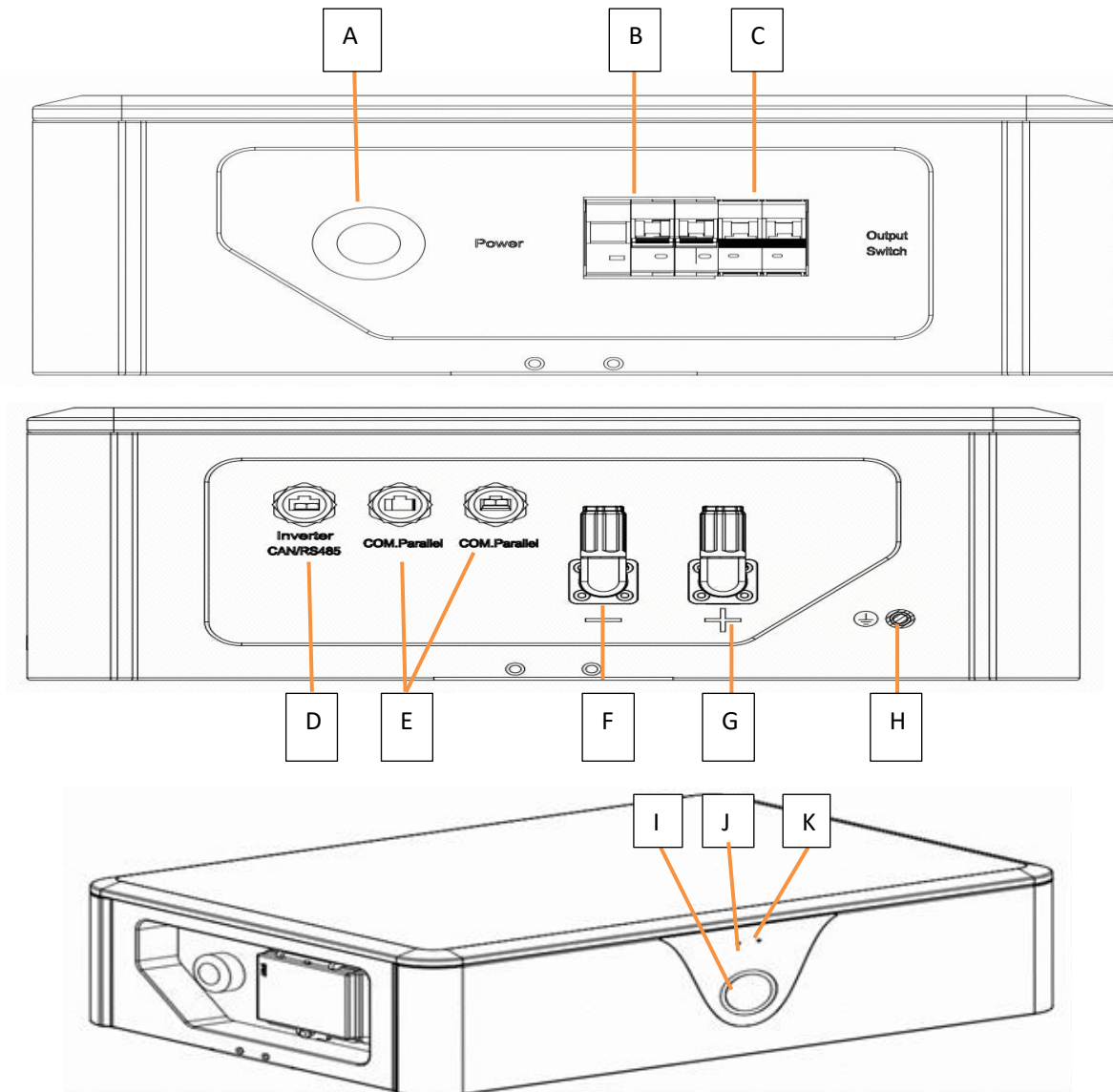

No.	Items	Usage description
A	Antenna	Use to receive wifi signal.
B	Power Switch	Use to power supply of the system, when the switch is on, the BMS is powered on and the battery system starts.
C	Output Switch	Use to control external output, when the switch is on, power output.
D	Inverter CAN/RS485	Use to communication between battery and inverter.
E	COM parallel port	Use to communication connection between battery systems in parallel.
F	Negative Terminal	Use to connect the inverter/charger.
G	Positive Terminal	Use to connect the inverter/charger.
H	Grounding	Used to connect battery with ground.
I	Run	Use to display run state.
J	Alarm	Use to display alarm state.
K	Capacity indication	Use to display capacity.

3.3.3.1 D: Inverter CAN/RS485

Port	Pin No.	Definition	Remarks
Inverter CAN/RS485	1	Inverter_RS485B	Use to communication between battery and inverter.
	2	Inverter_RS485A	
	3	NC	
	4	Inverter_CANH	
	5	Inverter_CANL	
	6	NC	
	7	NC	
	8	NC	

3.3.3.2 E: COM parallel port

Port	Pin No.	Definition	Remarks
Parallel port	1	Parallel_CANH	Use to communication connection between battery systems in parallel
	2	Parallel_CANL	
	3	RS485A	
	4	NC	
	5	RS485B	
	6	NC	
	7	Reserved_RS485A	
	8	Reserved_RS485B	

3.3.3.3 I/J/K: Indication light

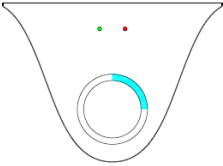
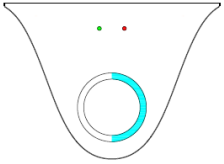
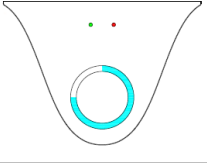
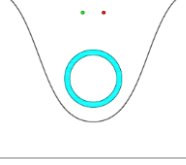
Items	Specification
Run	●
Alarm	●(Flash)
Protect	●
0~25% Capacity indication	
25%~50% Capacity indication	
50%~75% Capacity indication	
75%~100% Capacity indication	

4. Installation

4.1 Preparation

4.1.1 Safety Compliance







The system installation must be finished by qualified person(s), during the whole installation process, please strictly follow the local safety regulations and related operating procedures.

4.1.2 Environment

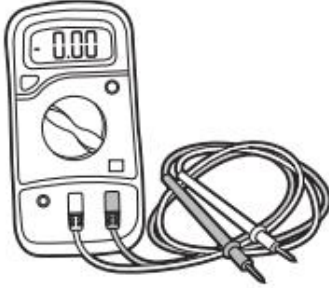
The operating environment shall meet the following requirements:

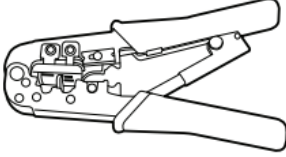
Category	Description
Application scenarios	Residential & commercial energy storage systems
Operating Environment	Indoor and place away from strong electromagnetic radiation
Recommended salt spray	An area 2km from the coast
Ambient Temperature	-10~40°C (14~104°F)
IP grade	IP55
Storage Temperature	Short time(≤1month): -20~45°C (-4~110°F) Long time (≥1month): 5~35°C (41~95°F)
Operating Humidity	0 ~ 85%
Install Altitude	≤4000m
Safety requirement	<ul style="list-style-type: none"> Do not expose the battery to direct sunlight, rain and snow. Do not place the battery within children/pet touchable area. Do not place the battery near heat source and flammable material Do not drop, deform, impact, cut or spearing with a sharp object. Do not put heavy things on battery. Do not disassemble the battery without Manufacturer's permission. No conductive dust and water or other liquid to contact battery. Follow the emergency measure if there is water invasion or electrolyte and gas leakage. Contact your supplier within 24 hours if any product failure happens.

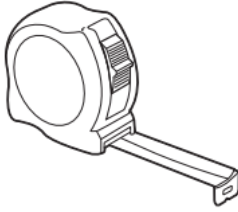
4.1.3 Tools

Tools	
<p>Torque screwdriver</p> 	<p>Multi-meter</p> 
<p>Torque wrench</p> 	<p>Cable crimper</p> 
<p>Phillips-head screwdriver</p> 	<p>Tape measure</p> 
<p>Phillips-screwdriver bit</p> 	<p>Drill</p> 









4.2 Inspection

4.2.1 Unpacking

- Please load and unload it in accordance with the specified requirements to prevent sun and rain when you receive the equipment.
- Please check and confirm the goods (such as quantity, appearance, etc.) according to the "scope of delivery" before unpacking.
- Do light take and put during unpacking process to protect the surface coating of the object;
- Please record and feedback to the manufacturer if the inner packing is damaged after unpacking.

4.2.1 Packing list

- Check the battery package, type, quantity, appearance and other components.

Parts	QTY	Photo
Battery parallel communication cable_RJ45*2	1pcs	
M8 * 16 outer hexagon combination bolt	4pcs	
M4 * 10 outer hexagon screw	24pcs	
Terminal resistance	1 pcs	
Inverter communication cable_RJ45_Gray*	Optionnal	
Connecting cable from BAT+ to inverter	1pcs	
Connecting cable from BAT- to inverter	1pcs	
Ground cable	1pcs	

NOTICE

Usually user equip inverters of different brands, which need prepare different kinds of communication cable. The dealer can inform us the inverter brand which this battery support, such as SMA, Fronius, Goodwe, Growatt, Solis, Magarevo, Lux power, SAJ. Before installation, connect the matching inverter with the dealer to avoid the mismatch of the inverter in the installation process.

4.3 Start Installation

Qualified person

4.3.1 Remainder

Please check again the following conditions or equipment whether meet the requirements before installation:

- Check if there's enough space for installation, and if the load-bearing capacity of the bracket or cabinet meets the weight requirements.
- Check whether the power cable pair(s) used meets the maximum current requirement for operation.
- Check whether the overall layout of power supply equipment and batteries at the construction site is reasonable.
- Check whether the installer is wearing anti-static wristband.
- Check whether there're two people on the construction site for installation work.
- Check if there's potential risks at location of installation site, e.g flooding, sun exposure, corrosion, and salt spray.

4.3.2 Procedures

CAUTION

Injuries may result if the product is lifted incorrectly or dropped while being transported or mounted. Wear suitable personal protective equipment for all work on the product.

4.4 Installation Steps

4.1 Mounting and securing of the base

Before installing a battery module, secure the base to the ground using four M8*16 hex bolts.

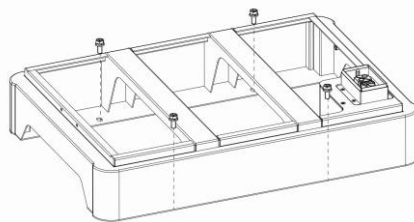

NOTICE

Seismic zone please operate as follows, non-seismic zone can choose not to drill.

4.2.2 Mounting and securing the battery modules and control module

- 1) The battery modules are stacked on the base.
- 2) Lock the four M4*10 screws on both sides of the base and battery module.
- 3) After the four battery modules are stacked, stack the control modules and lock the M4*10 screws.

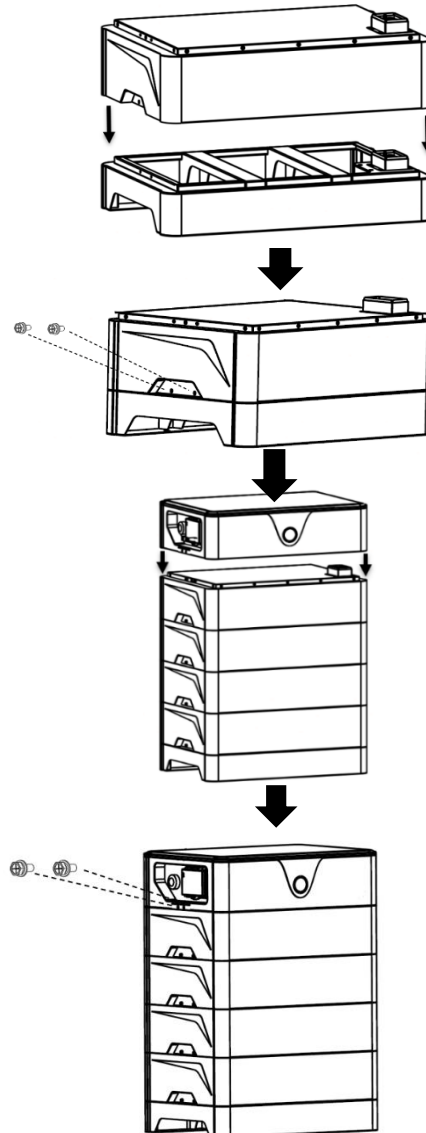

NOTICE

This series of models supports up to 4 battery module stacks. More than 4 battery modules stacked can result in damage to Lithium Batteries and will void warranty!

It is not allowed to mix old and new battery modules, and battery modules of the same batch must be used. Mixed use of new and old battery modules will affect the consistency of the battery system, the capacity and cycle life of the battery system.

5. Cable connection and commissioning

Qualified person

5.1 Get battery ready

- 5.1.1 Ensure all the battery is in OFF mode, check and confirm the installation is tighten and stable.
- 5.1.2 Check the number and specification of cable kit accessories are correct according to the Scope of delivery item, if you are making cable yourself, please follow manufacturer's requirements.
- 5.1.3 Switch on all battery individually before wiring, check whether there is any alarm/protection information, if yes, turns to troubleshooting. Then switch off all batteries.

5.2 Grounding cable connection

The battery system has 2 grounding point, respectively located in the base and control module. You can connect the wire according to the actual situation, just connect one grounding point. The ground cable must use a cable with a specification greater than 10 AWG.

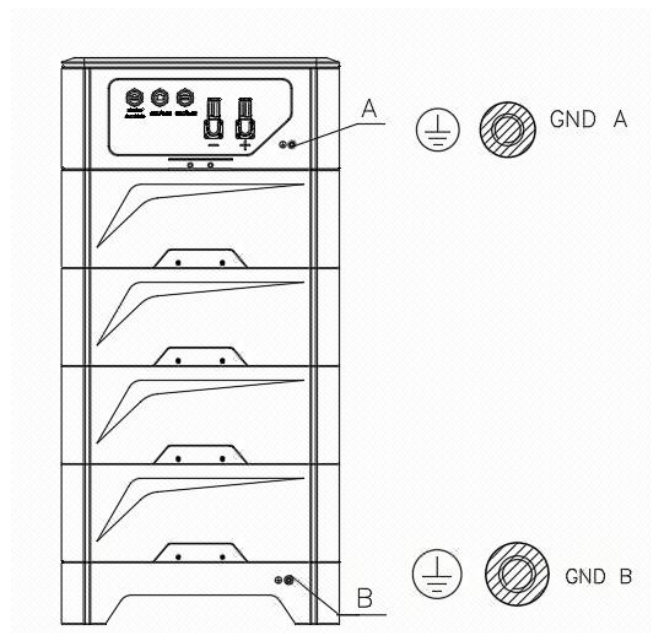

5.3 Single battery connection

The following illustration shows battery system how to connect to inverter.

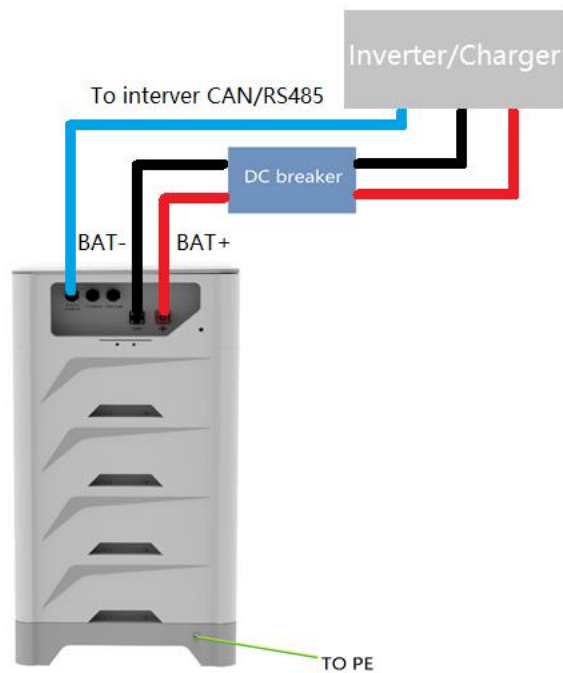

CAUTION

Verify polarity at all connections with a standard voltmeter before energizing the system. Reverse polarity at the battery terminals will void the Warranty and destroy the batteries. Do not short circuit the batteries.

5.4 Multi-cluster connection

5.4.1 Installation recommended distance

For connecting multiple units: Maintain the recommended distance among battery units's side or wall- **at least 12inches (300mm)**. And keep battery unit' side at lease 20inches (500mm) away from Inverter or ceiling.

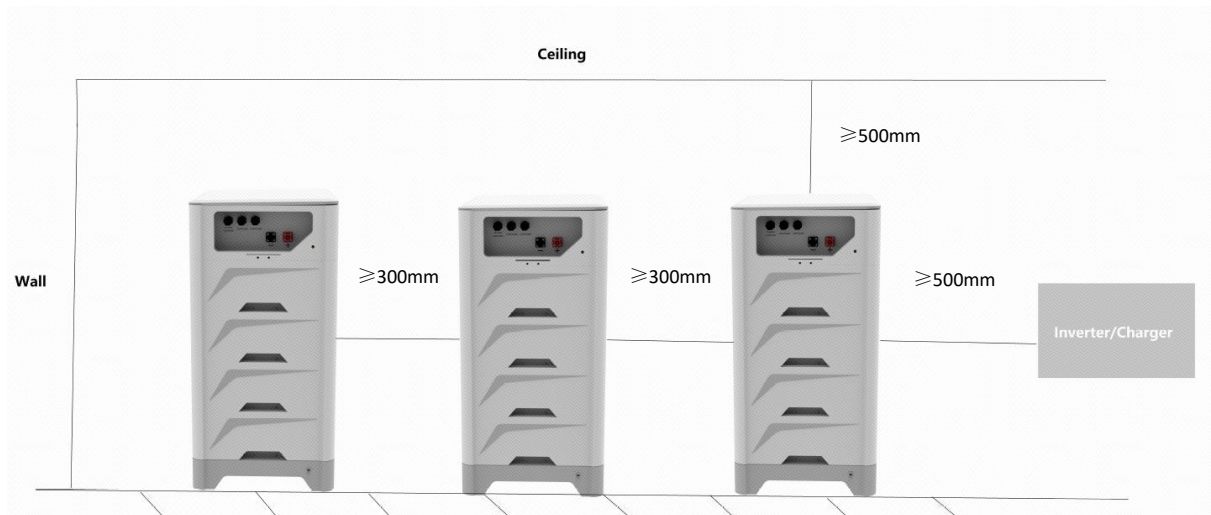

5.4.2 Communication port connection

When multiple battery systems need to be used in parallel, the following wiring methods shall be installed for communication wiring.

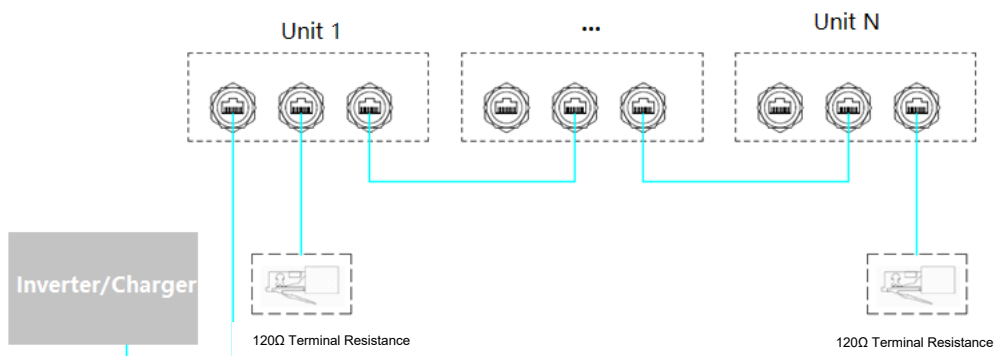

⚠ CAUTION

Verify polarity at all connections with a standard voltmeter before energizing the system. Reverse polarity at the battery terminals will void the Warranty and destroy the batteries. Do not short circuit the batteries.

5.4.3 Wire the battery cables

When multiple battery systems need to be used in parallel, please follow the following wiring methods.

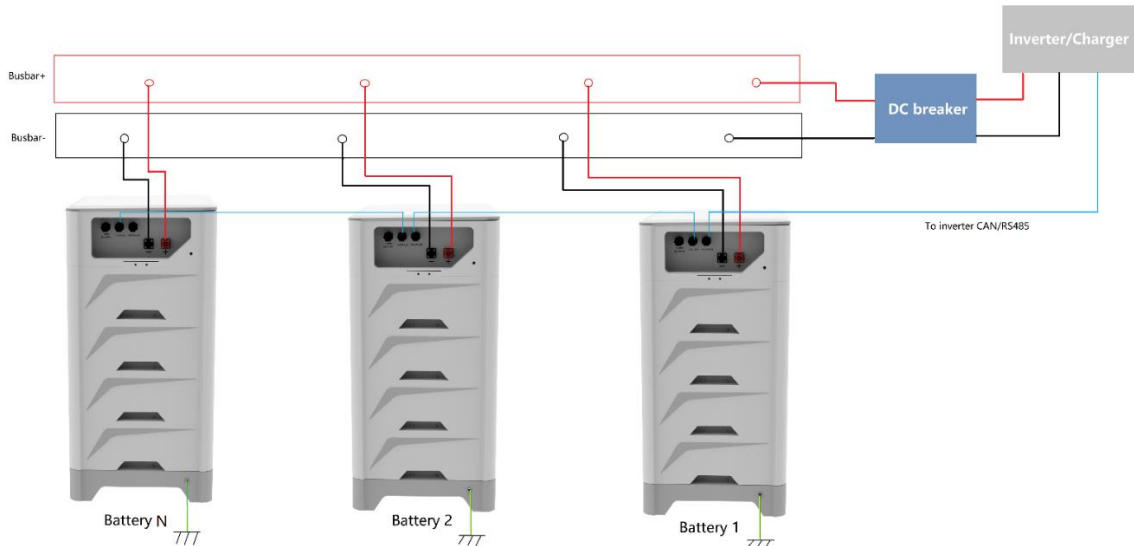

CAUTION

For parallel connecting: Maintain identical wire lengths and wire gauge from each Battery terminal to the common bus.

5.5 Turn on the Unit

5.5.1 Switch on all battery modules.

5.5.2 Turn on the breaker between the inverter and battery if there is any, then turn on the inverter/charger isolator.

5.5.3 Finish the setting on inverter/charger or any other control devices, if everything is correct, you are ready to use the system.

CAUTION

Before starting the battery system, please confirm that the connection between the battery system and the inverter is correct.

5.6 Turn off the Unit

5.6.1 Turn off the inverter.

5.6.2 Turn off the disconnection breaker if there is any.

5.6.3 Turn off all batteries signal switch.

⚠ CAUTION

When the battery system is left unused for a long time or fails, it is necessary to turn off the power in time.

6. Protective circuit specification

The Battery Management System (BMS) can monitor and optimized each single cell during charge & discharge, to protect the battery pack over charge, over discharge, short circuit, etc.

No	Items	Description	
1	Over charge	Over-charge alarm for each cell	3.55±0.03V
		Over-charge protection for each cell	3.60±0.03V
		Over-charge release for each cell	3.34±0.03V
		Over-charge alarm for total voltage	3.6V per cell
		Over-charge protection for total voltage	3.65V per cell
		Over-charge release for total voltage	3.40V per cell
		Protection delay time	2s
		Over-charge release method	Under the release voltage
2	Over discharge	Over-discharge alarm for each cell	3.1±0.03V
		Over-discharge protection for each cell	2.90±0.03V
		Over-discharge release for each cell	3.15±0.03V
		Over-discharge alarm for total voltage	3.00V per cell
		Over-discharge protection for total voltage	2.70V per cell
		Over-discharge release for total voltage	3.15V per cell
		Protection delay time	2s
		Over-discharge release method	Charge to recovery
3	Over current	Charge over current alarm	55±5A
		Charge over current protection	60±5A
		Protection delay time	5±1s
		Charge over current release method	Auto release after 1min;
		Discharge over current alarm	55±5A
		Discharge over current protection	60±5A
		Protection delay time	5±1s
		Over current release method	Auto release after 1min
4	Charge over temperature	Alarm @50±3°C, Protect @55±3°C, Release @45±3°C	
		Protection delay time: 2s	
5	Discharge over temperature	Alarm @60±3°C, Protection @65±3°C, Release @55±3°C	
		Protection delay time: 2s	
6	Charge low temperature	Alarm @3±3°C, Protect @0±3°C, Release @5±3°C	
		Protection delay time: 2s	
7	Discharge low temperature	Alarm @-15±3°C, Protect @-20±3°C, Release @-10±3°C	
		Protection delay time: 2s	
8	SOC	LOW SOC Alarm	10%

7. Troubleshooting Guide and summary

7.1 Troubleshooting

Fault	Fault analysis	Solution
Indicator is not on &No power output	The battery module is not properly installed.	Reinstall the battery module correctly.
	The base is not properly installed.	Reinstall the base correctly.
	Battery module failure	Check the connector and replace the battery module.
	Control module failure	Check the connector and replace the control module.
	Battery voltage is too low.	Ensure at least two battery modules.
Red light is on& No power output	Battery module communication failure	Reinstall the battery module correctly or replace the battery module.
	BMU failure	Replace BMU.
	Battery High-Voltage	Reduce charging voltage or stop charging.
	Battery Low-voltage	Low power, please charge immediately.
	Battery High-temperature	Stop charging or discharging until battery temperature fall below the recover temperature.
	Battery Low-temperature	Stop charging or discharging until battery temperature rise above the recover temperature.
	Battery charge/discharge Over-Current	Reduce the charging current or discharging power, and battery will auto release in 1minutes.
	Battery Short-Circuit	Check the external power wire of the battery, eliminate short-circuit connection. Pay attention to the correct the start-up sequences.
	Relay adhesion	Replace relay

NOTICE

If the problem is still not solved after troubleshooting, please contact the manufacturer.

7.2 Key points summary

1. Each Lithium Battery contains circuitry that protects the Lithium Ferro Phosphate cells from overcharging, over-discharging, and excessive load amperage. If the values specified are exceeded, the battery will enter a protective shut down state. In some cases, this may result in the need to re-initialize an inverter charger or other equipment in the installation. In other cases, the inverter's system settings may be saved within the inverter memory storage and will not need to be reset. This is not an absolute standard but is common among most inverter chargers. Check your inverter manufacturer specifications.
2. If the battery enters a self-protective mode, negligible voltage readings will be present until the unit is reset. In some instances, after unused for long time, a charge might need to be manually applied to the energy storage bank. Should this occur, please contact ENSMART for technical support. Lithium Batteries are designed to remain robust and safe under most circumstances.
3. Although each Lithium Battery contains circuitry that protects the Lithium Ferro Phosphate cells from overcharging, over-discharging and excessive load amperage, Lithium Batteries must always be installed with a charge controller and the appropriate settings to protect the batteries from open PV and other high voltage sources. Lithium Batteries alone will not protect from extreme electrical phenomena.
4. Grid tied system: Once the Lithium Battery has been installed, turn on the entire system to test. Once testing has been completed, please disconnect the batteries from the load center until your local Utility Inspector is ready to turn on the entire system. The charge controllers and inverter monitoring systems can drain the Lithium Batteries over an extended period when the entire system is not fully operational due to the electrical draw of the system components.
5. Off grid systems: Do not connect the Lithium Batteries until the entire system is ready to turn on and is fully operational.
6. Other chemical reaction: because batteries utilize a chemical reaction, battery performance will deteriorate over time even if stored for a long period of time without being used. In addition, if various usage conditions such as charge, discharge, ambient temperature, etc. are not maintained within the specified ranges, the life expectancy of the battery may be shortened or the device in which the battery is used may be damaged by electrolyte leakage. If the discharge time is much shorter than the normal after full charged, even battery is charged correctly, and this may indicate it is time to change the battery.

8. Transport, Storage

- Do not violently shake, impact or squeeze, and prevent sun and rain during the transportation.
- Do light take and put and strictly prevent falling, rolling, and heavy pressure during loading and unloading.
- The battery should be placed in a dry, clean, dark, and well-ventilated indoor environment for long-term storage, and the recommended storage temperature range is 15~30°C.
- No harmful gases, flammable and explosive products and corrosive chemical substances in the storage location.
- The batteries should be stored and transported in close to 50% SOC, do not store over 80%SOC for long time.
- If do not use for a long time, the battery needs to be charged every 6 months.
- No fall down, no pile up over 6 layers, and keep face up.

9. Disposal of battery

Disposal of battery must comply with the local applicable disposal regulations for electronic waste and used batteries, please review your local Battery recycling or management regulations or contact your supplier for more information.



www.ensmartpower.com

UNITED KINGDOM

Unit 25 Broadfields Farm, Dunmow Road,
Rayne, CM77 6SA, Essex, UK
T: + 44 20 3808 85 60
E: info@ensmart-ess.co.uk

TURKEY

Halk Cad. No:8/A3, Atasehir,
Istanbul, Turkey 34752, TR
T: +90 216 225 84 66
E: sales@ensmartpower.com

Follow us on



[/ensmartpower](#)



[/ensmart_power](#)



[/ensmartpower](#)



[/ensmartpower](#)