



SolarAll-H 3-Phase Hybrid Inverter

Models 10kW-12kW-15kW-20kW



User Manual

Contents

1. Overview.....	1
1.1 Scope of application.....	1
1.2 Applicable personnel.....	1
1.3 Symbol definition.....	1
2. Safety precautions.....	3
2.1 Operation safety.....	3
2.2 PV string safety.....	3
2.3 Battery safety.....	4
2.4 Inverter safety.....	4
2.5 Personnel requirements.....	5
2.6 Description of inverter symbols.....	5
3. Equipment inspection and storage.....	6
3.1 Inspection before receipt.....	6
3.2 List of deliverables.....	6
3.3 Equipment storage.....	8
4. Product introduction.....	9
4.1 Product overview.....	9
4.2 Application scenario.....	9
4.3 Working mode.....	9
4.3.1 Self-generation and self-use mode.....	9
4.3.2 Time-of-use tariff mode.....	10
4.3.3 Disaster Recovery Mode.....	11
4.3.4 Off-grid Mode.....	12
4.3.5 Time charge and discharge mode.....	12
4.4 Inverter operation mode.....	13
4.5 Appearance description.....	14
4.5.1 Appearance introduction.....	14
4.5.2 Dimensional description.....	15
5 Installation.....	16

5.1 Installation requirements.....	16
5.1.1 Installation environment requirements	16
5.1.2 Installation carrier requirements	16
5.1.3 Installation angle requirements	16
5.2 Installation tools.....	18
5.3 Hand the inverter.....	20
5.4 Install the inverter	20
6. Electrical connection.....	22
6.1 Electrical system connection diagram	22
6.2 Port wiring instruction	23
6.3 Connect the PV string input cable and battery cable	24
6.4 Connect the AC grid connection cable.....	26
6.5 Connect the AC load cable.....	27
6.6 Protective ground wire connection	29
6.7 WIFI communication interface connection (optional).....	30
6.8 X1 board communication port connection.....	30
6.8.1 Smart meter connection	31
6.8.2 BMS communication line connection.....	33
6.8.3 DRMS logic interface connection.....	34
6.8.4 Parallel communication line connection.....	34
6.8.5 Introduction to dry contacts	36
7 Equipment commissioning.....	37
7.1 Inspection before power-on	37
7.2 Initial power-on of equipment	37
8. System debugging (WIFI stick is optional)	38
8.1 Indicator description	38
8.2 Inverter parameters setting via APP.....	38
8.2.1 Software Acquisition.....	38
8.2.2 User registration and login.....	38
8.2.3 Add inverter information and hotspot connection	39

8.2.4 Home page	42
8.2.5 Alarm Information	42
8.2.6 Energy Statistics.....	43
8.2.7 PV/Battery Status.....	44
8.2.8 Settings.....	45
8.2.9 System Data	48
8.2.10 Version Information	50
8.2.11 Operation Records.....	51
9. Troubleshooting and maintenance	52
9.1 App alarm display and solution.....	52
9.2 Regular maintenance.....	54
10. Technical parameters	56

1. Overview

This manual mainly introduces the product information, installation, electrical connection, configuration debugging, troubleshooting and maintenance, technical parameters, and other contents of the three phase hybrid inverter. Please read this Manual carefully before installing and using this product to understand the product safety information and familiarize yourself with the functions and features of the product. The Manual may be updated from time to time, please get the latest version of the material from the official website to obtain more information about the product.

1.1 Scope of application

This Manual is applicable to the following inverter models:



Model	Rated output power	Rated output voltage
SolarAll-H 10000T	10000W	380/400V, 3L/N/PE
SolarAll-H 12000T	12000W	
SolarAll-H 15000T	15000W	
SolarAll-H 18000T	18000W	
SolarAll-H 20000T	20000W	



1.2 Applicable personnel

This Manual is only for professional and technical personnel who are familiar with local regulatory standards and electrical systems and who have been professionally trained and are familiar with the knowledge related to this product.

1.3 Symbol definition

The Manual provides relevant safety operation information and highlights it with appropriate symbols in order to ensure the safety of the user's person and property when using the PV grid-connected inverter and the efficient use of the product. Please first fully understand and absolutely comply with this highlighted information in order to avoid personal injury and property damage. The following is a list of symbols used in this Manual.

 Danger	<p>It indicates a high potential hazard that, if not avoided, will result in death or serious injury.</p>
 Warning	<p>It indicates a moderate potential hazard that, if not avoided, will result in death or serious injury.</p>

 Caution	It indicates a low potential hazard that, if not avoided, will result in moderate or minor injury.
 Attention	It indicates a potential risk that, if not avoided, will result in the equipment not operating properly or cause property damage.
 Note	It indicates an emphasis and additional description of the content, and may also provide tips for optimal use of the product that may help you solve an issue or save you time.

2. Safety precautions



The Manual on safety precautions contained in this document must always be observed when operating the equipment.

 Attention	<p>The inverter has been designed and tested in strict accordance with safety regulations, but as an electrical equipment, the relevant safety instructions need to be observed before any operation of the equipment, and improper operation may result in serious injury or property damage.</p>
---	--

2.1 Operation safety

 Attention	<p>Please read this Manual carefully to fully understand the product and precautions before installing the equipment.</p> <p>All operations of the equipment must be carried out by professional electrical technicians who are familiar with the relevant standards and safety codes of the project site.</p> <p>Insulated tools and personal protective equipment must be used when operating the inverter to ensure personal safety. Static gloves, static hand ring, anti-static clothing, etc. must be worn when contacting electronic devices to prevent the inverter from being broken by static electricity and causing damage.</p> <p>Damage to the inverter or injury to personnel caused by not following the requirements of this manual for installation, use and configuration is not covered by the equipment manufacturer's responsibility.</p>
--	---

2.2 PV string safety

 Danger	<p>Please use the DC terminal block provided with the box to connect the inverter DC cable. The use of other types of DC terminals may lead to serious consequences, so the damage caused by the equipment is not covered by the equipment manufacturer's responsibility.</p>
 Warning	<p>Please make sure that both the component frame and the bracket system are well grounded.</p> <p>Please make sure the cable is tightly connected and not loose after the DC cable is connected.</p> <p>Check that the battery DC terminals are correctly wired and that the voltage is within the allowable range with a multi-meter.</p> <p>Please do not connect the same PV string to more than one inverter, otherwise the inverter will be damaged.</p>

2.3 Battery safety

 Warning	<p>Please read the battery safety content introduced in the User Manual carefully to understand the product before installing the equipment, and please strictly follow the requirements in the User Manual.</p> <p>Please charge the battery strictly according to the corresponding model in the User's Manual if the battery has been completely discharged.</p> <p>Battery current may be affected by external environment, such as: temperature, humidity, etc., which may lead to battery current limiting and affect loading performance of the battery.</p> <p>Please contact the after-sales service center as soon as possible if the battery fails to start. Otherwise, the battery may be permanently damaged.</p> <p>Check if the battery DC terminals positive and negative are wired properly and the voltage is within the allowable range with a multimeter.</p> <p>Please do not connect the same battery set to more than one inverter, as this will cause damage to the inverter.</p>
---	---

2.4 Inverter safety





 Warning	<p>Please ensure that the voltage and frequency of the grid connection point comply with the inverter grid connection specifications.</p> <p>It is recommended to add protection devices such as circuit breakers or fuses on the AC side of the inverter, and the protection inverter specifications should be greater than 1.25 times the maximum current of the AC output of the inverter.</p> <p>The protective ground wire of the inverter must be firmly connected, and when there are multiple inverters, make sure that the protective ground points of all inverter chassis enclosures are connected equipotentially.</p> <p>If the battery is not configured in the PV system, the BACK-UP off-grid function is not recommended and the resulting risk of system power usage will not be covered by the equipment manufacturer's warranty.</p>
---	--

2.5 Personnel requirements

 Attention	<p>Certain parts may become charged or hot when the inverter is in operation. Improper use, incorrect installation or operation may result in serious injury to persons or property. Transportation, handling, installation, startup and maintenance operations must be performed by a qualified electrical engineer.</p>
---	---

2.6 Description of inverter symbols

The three phase hybrid inverter carries a number of safety-related labels. Please read and fully understand the contents of these labels before installing the product.

Symbol	Symbol name	Symbol meaning
	<p>It indicates the danger of residual voltage in the inverter.</p>	<p>Please wait for 5 minutes until the capacitor is completely discharged after the DC side of the inverter has been disconnected with power for a period of time.</p>
	<p>It indicates the danger of high voltage.</p>	<p>High voltage exists during inverter operation. If you need to operate the inverter, please make sure the inverter is disconnected.</p>
	<p>It indicates to be careful of high temperature surface.</p>	<p>The temperature of inverter housing is high during operation, so do not touch it, otherwise it may cause burns.</p>
	<p>It indicates grounding terminal.</p>	<p>Connect the inverter to ground for grounding protection purpose.</p>
	<p>It indicates reading the manual.</p>	<p>Please read and understand this Manual carefully before installing the inverter.</p>

3. Equipment inspection and storage

3.1 Inspection before receipt

Please check the following in detail before signing for the product:

1. Check the outer packaging for damage, such as holes, deformation, cracks or other signs that may cause damage to the equipment inside the box; if there is damage, do not open the packaging and contact your dealer.







2. Check if the inverter model is correct, if there is any discrepancy, please do not open the package and contact your dealer.



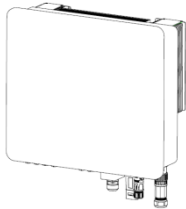

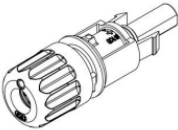
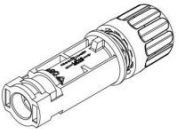
3. Check that the type and quantity of the deliverables are correct and that there is no damage to the appearance. Please contact your dealer if there is any damage.





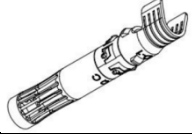
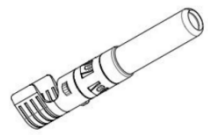
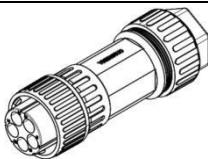
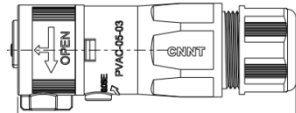
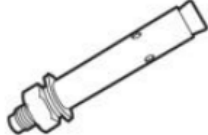

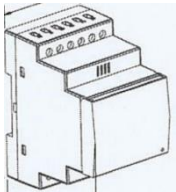
3.2 List of deliverables

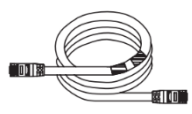
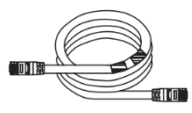
Check the deliverables for completeness after unpacking the inverter and contact your dealer if any components are found to be missing or incomplete.

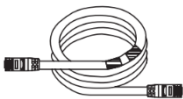
Table 3-1 Components and mechanical parts to be delivered

Series No.	Picture	Description	Quantity
1		Inverter	1PC
2		Wall-mounted rear cover	1PC
3		PV+ wire end input terminal plastic case	4PCS
4		PV- wire end input terminal plastic case	4PCS
5		BAT+ wire end input terminal plastic case	2PCS
6		BAT- wire end input terminal plastic case	2PCS
7		PV+ wire end input terminal metal core	4PCS
8		PV- wire end input terminal metal core	4PCS

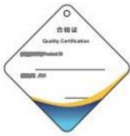
9		BAT+ wire end input terminal metal core	2PCS
10		BAT- wire end input terminal metal core	2PCS
11		AC grid terminal	1PC
12		AC load terminal	1PC
13		M8*80 expansion bolt	4PCS
14		Cross recessed hexagon head combination screw M6*20	1PC
15		Smart meter	1PC
16		CT (used with the meter)	3PCS
17		BMS communication line	1PC
18		DRMS communication line	1PC

19		Parallel communication line	1PC
20		WIFI acquisition bar (optional)	1PC
21		User Manual	1PC
22		Warranty Card	1PC
23		Certificate of Inspection	1PC
24		desiccant	1PC

3.3 Equipment storage

Please store the inverter according to the following requirements if it is not to be put into use immediately:

1. Ensure that the outer packing box is not removed and the desiccant inside the box is not lost.
2. Ensure that the storage environment is clean and the temperature and humidity range is appropriate.
3. Ensure that the inverter stacking height and direction are placed in accordance with the label instructions on the box.
4. Ensure that there is no risk of tipping of the inverters after stacking.
5. The inverter must be checked and confirmed by professional personnel before it can be used again after long-term storage.

4. Product introduction

4.1 Product overview

Three phase hybrid inverter inverter is a three-phase PV energy storage inverter that integrates grid-connected PV inverter and battery storage.

Three phase hybrid inverter inverter has a variety of built-in operating modes to suit the diverse needs of users.

Three phase hybrid inverter inverter provides a complete solution in times of rising energy costs such as oil and coal, declining energy subsidies for grid-connected PV systems, mountainous areas or base stations without grid access, uninterrupted power supply, and emergency power needs.

4.2 Application scenario

 <div style="background-color: #f4a460; padding: 5px; display: inline-block;">Warning</div>	<p>PV systems are not suitable for connection to equipment that depends on a stable power supply, such as life-sustaining medical equipment, etc. Please ensure that no personal injury is caused when the system loses power.</p> <p>Please avoid using loads with higher starting currents in PV systems as much as possible, otherwise the off-grid output may fail due to excessive instantaneous power.</p> <p>The inverter can restart automatically when the inverter overload protection occurs in a single time; if it happens several times, the inverter restart time will be extended, and you can restart the inverter immediately through the App if you need to restart the inverter as soon as possible.</p> <p>If the load capacity exceeds the rated power of the inverter when the grid is down, the off-grid function of the inverter will automatically shut down; if you want to start it, you need to turn off the large load and make sure the load power is less than the rated power of the inverter.</p> <p>The inverter can be used for normal household loads when it is in off-grid mode, e.g:</p> <p>Inductive load: 1.5P non-inverter air conditioners can be supported. Access to two or more non-inverter air conditioners may lead to unstable standby mode.</p> <p>Capacitive load: total power $\leq 0.66 \times$ inverter rated output power.</p>
--	--

4.3 Working mode

4.3.1 Self-generation and self-use mode

Functions:

Prioritizes the use of PV and battery energy, and does not use energy from the grid as much as possible.

Specific working methods:

1. When PV is sufficient, PV prioritizes power supply to the load, then charges the battery, and any remaining energy can be feed into the grid.

2. When PV is insufficient, the PV、 battery and power grid jointly supply power to the load.

3. When PV is not working, the battery and the grid work together to power the load. (priority battery power the load)

Attention : the anti-reverse function is not enabled by default.

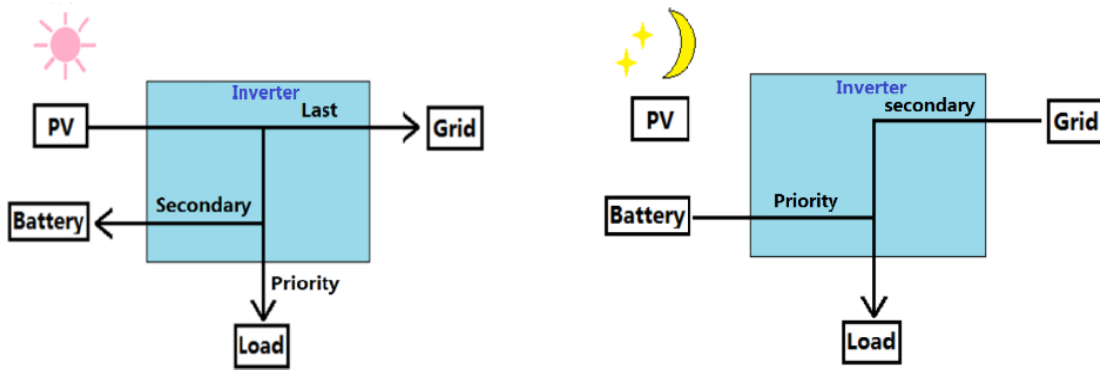

4.3.2 Time-of-use tariff mode

Functions:

Depending on the price of electricity at different times, during the valley period the power grid and PV give priority to load power supply, and the remaining energy charges the battery. The other period are spontaneous self-use mode.

Specific working methods:

During the valley time period: the grid and PV power the load first, and the remaining energy charges the battery.

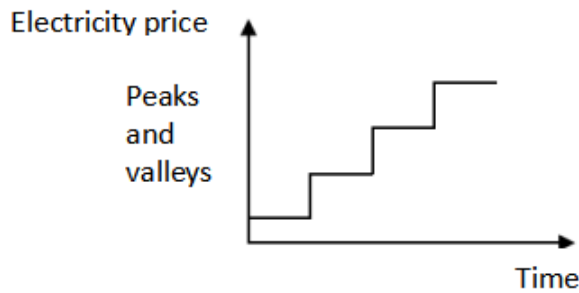

Valley time period:

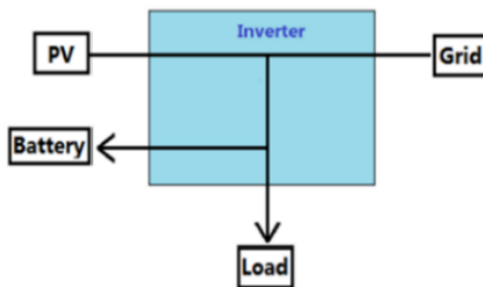

Average time period

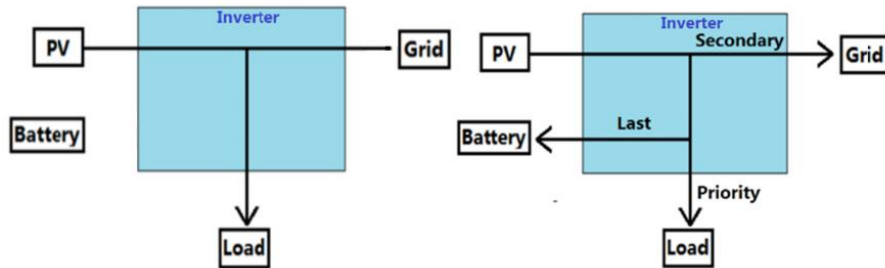

Peak time period:

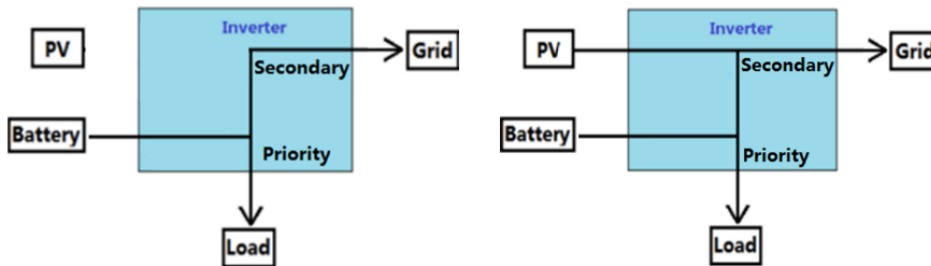

4.3.3 Disaster Recovery Mode

Functions:

When the power grid is abnormal, the energy storage system will provide power to the user separately. This mode can maintain power supply even when the user encounters special situations such as abnormal power grid conditions. (The battery requires a charging and discharging cycle every six months, which needs to be manually set)

Specific working methods:

1. PV and the power grid jointly supply power to the battery and load.(PV prioritizes charging the battery)
2. When the power grid is normal, the battery SOC remains fully charged.
3. The battery will only discharge when the power grid is abnormal.

Attention :the anti-reverse function is not enabled by default.

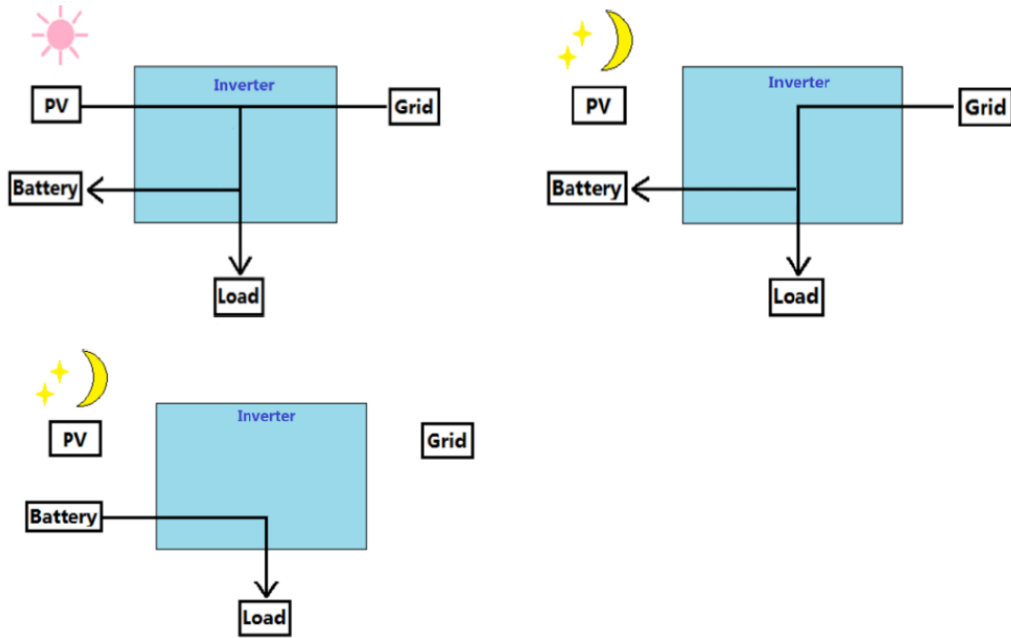

4.3.4 Off-grid Mode

Functions:

The PV and battery form an off grid system, and the inverter is used off the grid.

Specific working methods:

1. If the PV is sufficient, the PV prioritizes power supply to the load and excess energy is used to charge the battery.
2. If the PV is insufficient, the PV and battery will supply power to the load.
3. If the PV does not work, the battery supplies power to the load.

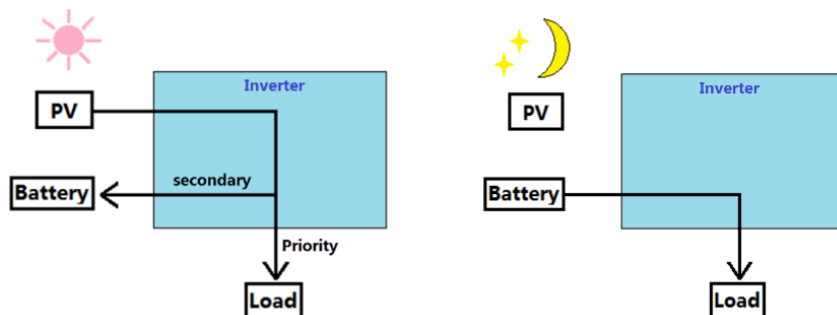

4.3.5 Time charge and discharge mode

Functions:

Set the charging and discharging time according to the user's need.

Specific working methods:

According to their own needs, the battery charge and discharge timing settings. if the power failure notification is known in advance, the battery can be filled remotely in advance for household load use.

4.4 Inverter operation mode

Table 4-1 Description of Inverter Operation Mode

Series No.	Mode	Description
1	Wait mode	Waiting phase after the inverter is powered on. Enter self-check mode when conditions are met. If there is a fault, the inverter enters the fault mode.
2	Self-check mode	The inverter continuously performs self-check, initialization, etc. before starting up. If the conditions are met, it enters grid-connected mode and the inverter starts grid-connected operation. If no grid is detected, it enters off-grid mode and the inverter runs off-grid. If the self-check is not passed, it enters fault mode.
3	Grid-connected mode	The inverter operates normally in grid-connected. If grid non-existence is detected or the grid conditions are detected that do not meet the grid connection requirements, it enters off-grid operation mode. If a fault is detected, it enters fault mode..
4	Off-grid mode	When the grid is disconnected or the grid conditions are detected that do not meet the grid connection requirements ,the inverter working mode switches to off-grid mode to continue to supply power to the load. If the grid conditions are detected to meet the grid connection requirements, it will enter the grid-connected mode. If a fault is detected, it enters fault mode.
5	Fault mode	If a fault is detected, the inverter enters fault mode, waits for the fault to clear, returns to the previous running mode.

4.5 Appearance description

4.5.1 Appearance introduction

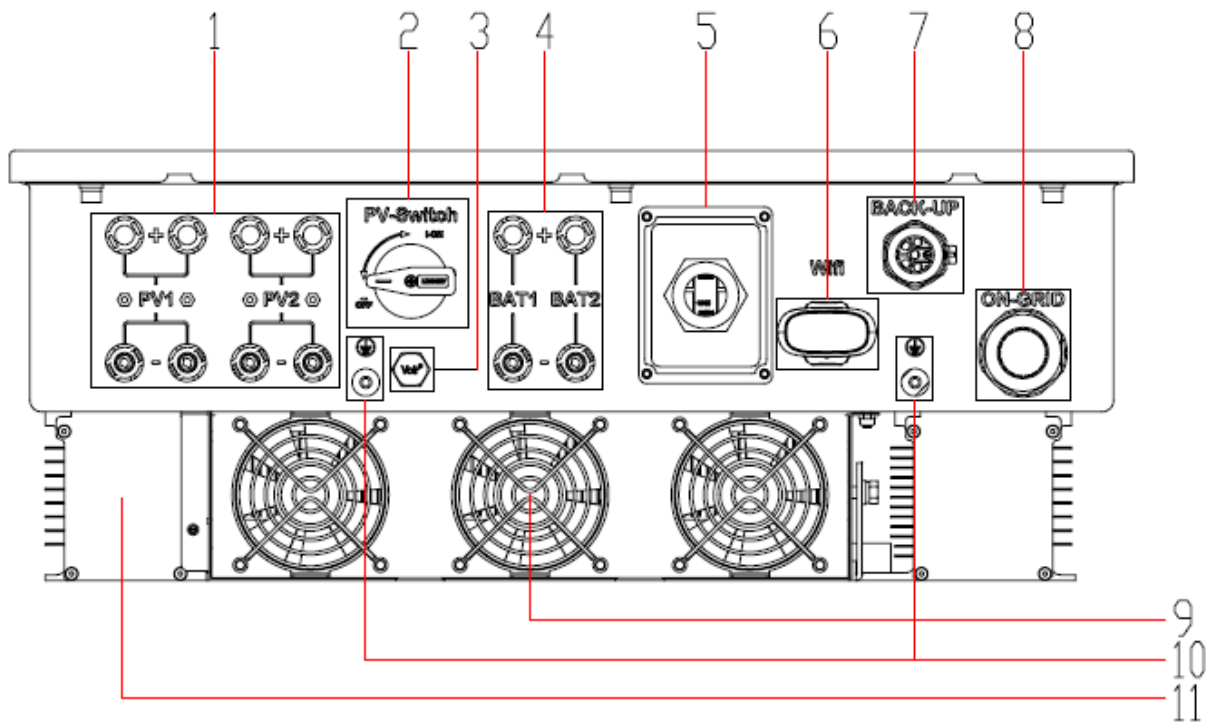

Figure 4.1 Illustration of the appearance of the hybrid inverter

Table 4-2 Appearance of a hybrid inverter

1	PV DC input port (PV+/-)	2	PV DC input switch
3	Waterproof and breathable device	4	Battery DC input port (BAT+/-)
5	Communication module interface	6	WiFi/4G interface
7	Off-grid AC wiring port	8	Grid-connected AC wiring port
9	Fan assembly	10	Protective ground terminal
11	inductive cooling box		

4.5.2 Dimensional description

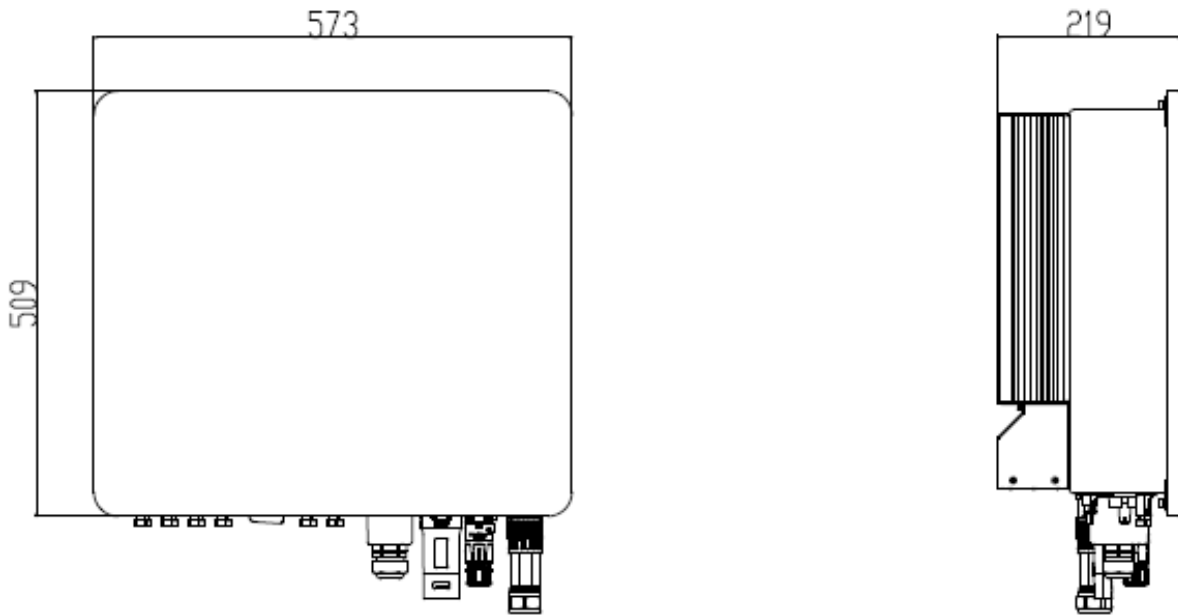

Figure 4.2 hybrid inverter dimensions

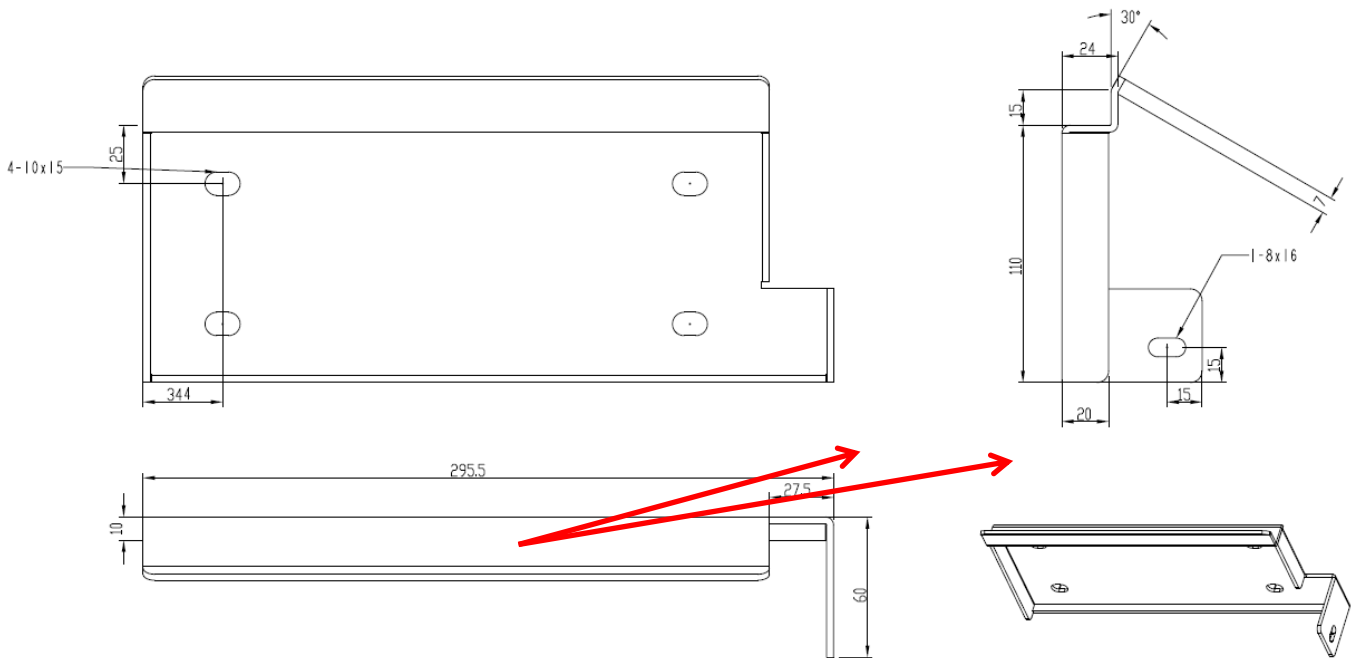

Figure 4.3 Wall mounted component dimensions

5 Installation

5.1 Installation requirements

5.1.1 Installation environment requirements

1. The equipment shall not be installed in flammable, explosive or corrosive environments.

2. The installation position shall avoid the water pipe and cable in the wall to avoid the danger when drilling.

3. Installation location shall avoid the range of children's access, and avoid installation in the easy-to-touch location. Please note that there may be high temperature on the surface when the equipment is operating, so please be careful of burns.

4. The inverter shall avoid the installation environment of sun, rain and snow, etc. It is recommended to be installed in a sheltered installation position, and if necessary, a sunshade can be built.

5. The installation space shall meet the requirements of equipment ventilation and heat dissipation and operation space.

6. The protection level of the equipment shall meet the indoor and outdoor installation, and the temperature and humidity of the installation environment shall be within the suitable range.

7. Please ensure that the equipment indicator and all labels can be easily viewed and the terminals are easy to operate.

8. The installation altitude of the inverter shall be lower than the maximum working altitude of 4000m.

9. Please keep away from strong magnetic field environment to avoid electromagnetic interference. Please install the equipment in accordance with the following requirements if there are radio stations or wireless communication equipment below 30MHz near the installation location:

1) Add multi-turn winding ferrite cores at the DC input wire or AC output wire of the inverter, or add low-pass EMI filters.

2) The distance between the inverter and the wireless EMI equipment shall exceed 30m.

5.1.2 Installation carrier requirements

1. The installation carrier shall not be flammable materials, and must have fireproof performance.

2. Please ensure that the installation carrier is strong and reliable and can carry the weight of the inverter.

3. Please do not install the inverter on a carrier with poor sound insulation, as the noise from the operation of the equipment may cause disturbance to the residents in the living area.

5.1.3 Installation angle requirements



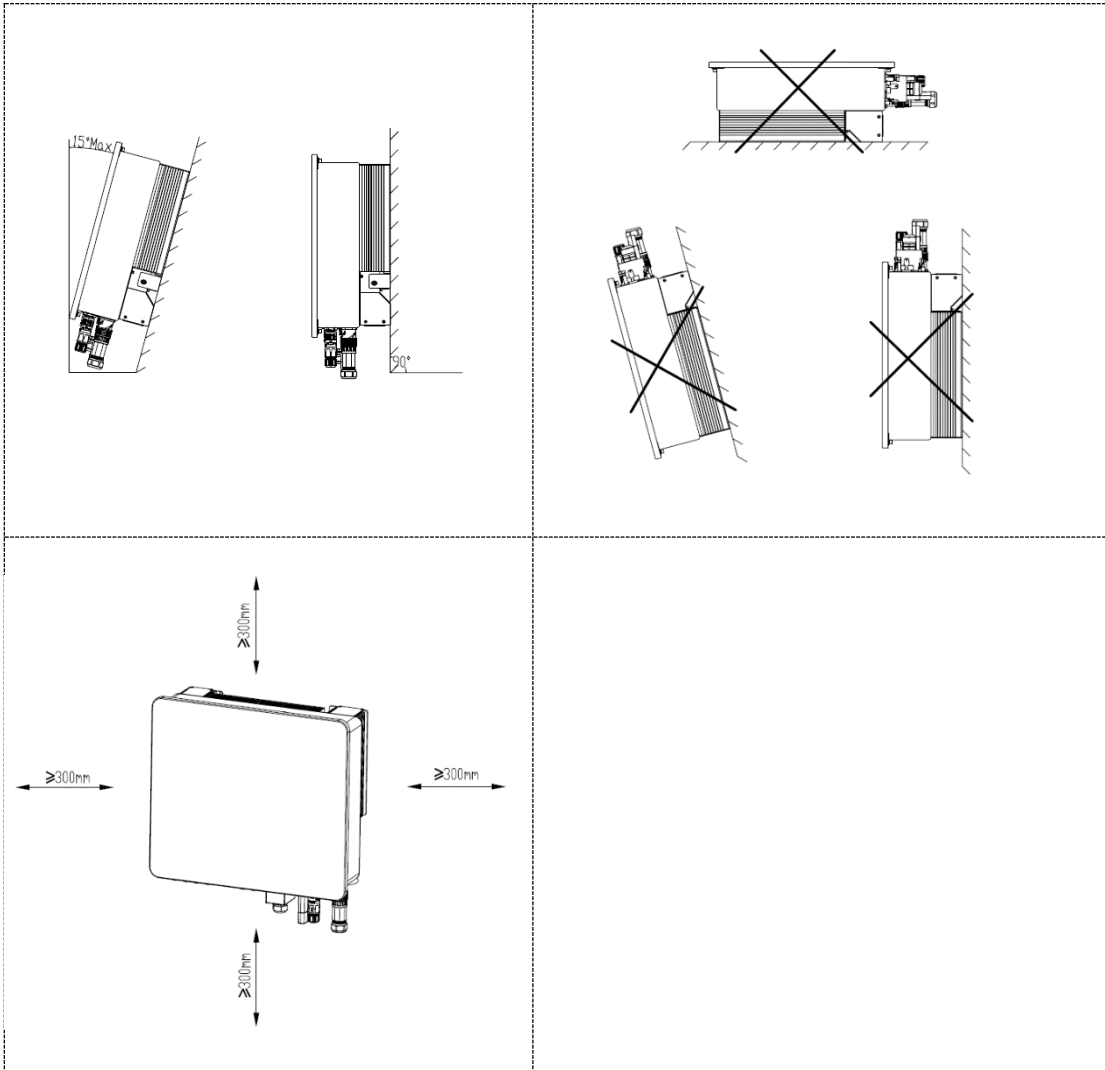

1. Recommended Installation angle of inverter: vertical or tilted back $\leq 15^\circ$.





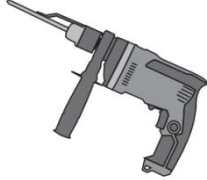
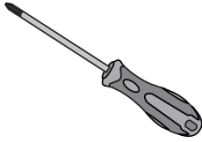

2. The Inverter shall not be installed upside down, tilted forward, tilted back beyond the angle, or horizontal.

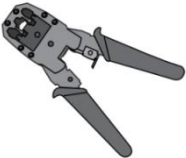

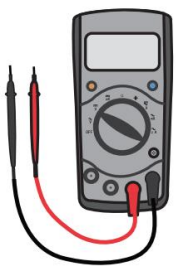
5.2 Installation tools

Table 5-1 List of Installation Tools

Series No.	Tools	Description	Function
1		Percussion drill Recommended 8mm drill	Wall drilling
2		6mm cross-head screwdriver	Removing, installing screws and wiring
3		4mm cross-head screwdriver	Removing and installing load terminal screws
4		Removal tool	Removal of PV, BAT line end terminals
5		Wire strippers	Stripping wire
6		Crimping pliers	Pressure welding grid, load end cable

7		6mm hex wrench	Fasten the grid terminal to the cable
8		Multimeter	Check whether the cable wiring is correct, the positive and negative battery terminals are correct and voltage, and grounding is reliable
9		Marking pen	Drilling mark
10		Tape	Measurement distance
11		Levelling instrument	Make sure the rear cover is level
12		Protective gloves	Wear when setting up the inverter
13		Goggles	Wear when drilling holes

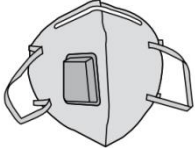
14		Dust mask	Wear when drilling holes
----	---	-----------	--------------------------

5.3 Hand the inverter

Remove the inverter from the outer packaging and handle it horizontally to the designated installation location. Open the outer packing box, two operators shall each reach under the inverter heat sink, carry the inverter out of the outer packing box and carry it to the designated installation position.

 Attention	<p>The operation of transportation, turnover and installation shall meet the laws and regulations and relevant standards of the country or region where it is located.</p> <p>Please pay attention to keep the balance when transporting the inverter as it is heavy, so that the operator will not be injured by the falling of the inverter.</p> <p>The power cable interface and signal cable interface at the bottom of the inverter cannot bear weight, please do not put the terminals in direct contact with the ground, please place the inverter horizontally.</p> <p>Please put foam or paper skin under the inverter when it is placed on the ground to avoid damaging the case.</p>
--	---

5.4 Install the inverter

 Attention	<p>Please ensure that the drilling position avoids water pipes and cables in the wall when drilling to avoid danger.</p> <p>Please wear goggles and a dust mask when drilling to avoid dust being inhaled into the respiratory tract or falling into the eyes.</p>
---	--

Step 1: Please choose a wall with sufficient bearing capacity, put the wall bracket horizontally on the installation wall, mark the position of the fixed wall mount to be drilled with a marking pen on the wall, then use the percussion drill to drill holes on the wall, keep the percussion drill perpendicular to the wall when drilling, do not shake it to avoid damaging the wall, reposition it if the hole drilling error is large.

Step 2: Insert the M8*80 expansion screw vertically into the hole, pay attention to the depth of the expansion screw shall not be too shallow.

Step 3: Put the wall bracket on the hole, and fix the wall bracket on the wall with nuts.

Step 4: Hang the inverter on the wall bracket, make sure the inverter is correctly inserted into the slot, and then fix the wall bracket to the inverter body case with screws, as shown in Figure 5.1.

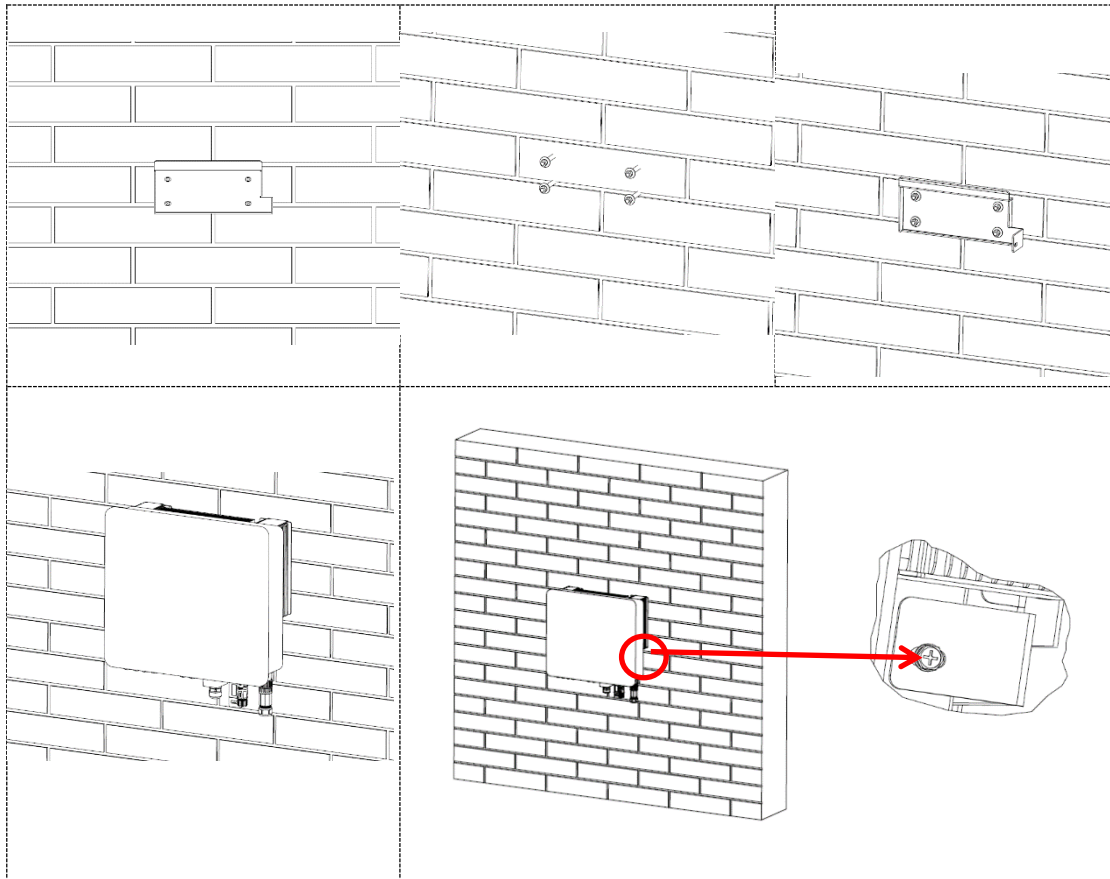



Figure 5.1 Wall-mounted parts installation instructions diagram

6. Electrical connection

6.1 Electrical system connection diagram

 Attention	<p>According to the regulatory requirements of different regions, the N and PE wires of the inverter ON-GRID and BACK-UP ports are wired differently, depending on the local regulatory requirements.</p> <p>The inverter ON-GRID and BACK-UP AC ports are equipped with built-in relays. When the inverter is in off-grid mode, the built-in ON-GRID relay is open; when the inverter is in grid-tied operation mode, the built-in ON-GRID relay is closed.</p> <p>When the inverter is powered up, the BACK-UP AC port is charged. Please power down the inverter if you need to perform maintenance on the BACK-UP load, otherwise it may cause electric shock.</p>
---	--

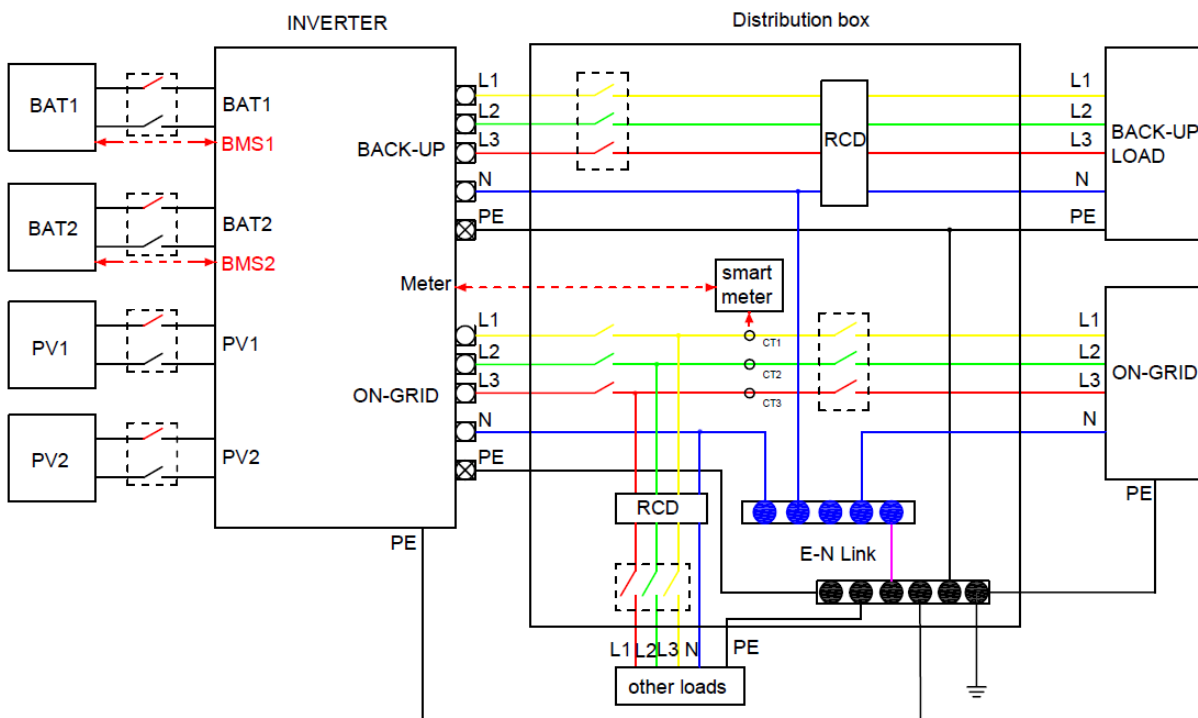
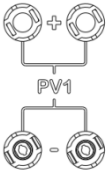
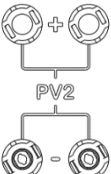

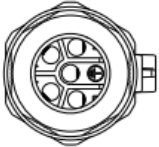

Figure 6.1 Electrical connection diagram

6.2 Port wiring instruction

Table 6-1 Cable Model and Specification Descriptions

Port	Definition	Cable type	Cable specification	
	+: Connect to PV positive pole	Outdoor Multi-Core Copper Cable	Recommended 6mm ² cross-sectional area of conductor, maximum current through the wire is 30A	
	-: Connect to PV negative pole			
	+: Connect to PV positive pole	Outdoor Multi-Core Copper Cable	Recommended 6mm ² cross-sectional area of conductor, the maximum current through the wire shall be at least 30A	
	-: Connect to PV negative pole			
	+: Connect to battery positive pole	Outdoor Multi-Core Copper Cable	Recommended 6mm ² cross-sectional area of conductor, the maximum current through the wire shall be at least 30A	
	-: Connect to battery negative pole			
<p>BACK-UP</p> 	AC load port	L1	Outdoor Multi-Core Copper Cable	Recommended 8mm ² cross-sectional area of conductor, maximum current through the leading wire is at least 35A, grounding cable specifications are the same as the phase conductor.
		L2		
		L3		
		N		
		PE		
	AC grid port	L1	Outdoor Multi-Core Copper Cable	Recommended 10mm ² cross-sectional area of conductor, maximum current through the wire is
		L2		
		L3		

		N		at least 60A, grounding cable specifications are the same as the phase conductor.
		PE		

6.3 Connect the PV string input cable and battery cable

 <div style="background-color: red; color: white; text-align: center; padding: 2px;">Danger</div>	<p>PV string connection:</p> <p>Please do not connect the same PV string to more than one inverter, otherwise the inverter will be damaged.</p> <p>Please confirm the following information before connecting the PV string to the inverter, otherwise it may lead to permanent damage to the inverter, and in serious cases, it may cause a fire resulting in damage to people and property.</p> <ol style="list-style-type: none"> 1. Please make sure that the maximum short-circuit current and maximum input voltage of each MPPT are within the allowable range of the inverter. 2. Please make sure the positive pole of PV string is connected to PV+ of the inverter, and the negative pole of PV string is connected to PV- of the inverter. <p>Battery cable connection:</p> <ol style="list-style-type: none"> 1. A short circuit in the battery may cause personal injury, and the instantaneous high current caused by a short circuit can release a large amount of energy, which may cause a fire. 2. Please make sure that the inverter and battery are disconnected and both the front and rear switches of the inverter are disconnected before connecting the battery cable. 3. It is forbidden to connect and disconnect the battery cable when the inverter is running, and the irregular operation may lead to the danger of electric shock. 4. Please do not connect the same battery set to more than one inverter, as this will cause damage to the inverter. 5. It is forbidden to connect loads between the inverter and the battery. 6. Please use insulated tools when connecting battery cables to prevent accidental electric shock or short-circuiting of the batteries. 7. Please make sure the battery open circuit voltage is within the allowable range of the inverter.
	<p>PV string connection:</p> <p>The PV string output does not support grounding. Please ensure that the minimum insulation resistance to ground of the PV string meets the minimum insulation impedance requirement</p>

	<p>before connecting the PV string to the inverter.</p> <p>Battery cable connection:</p> <p>The battery cable and the "BAT+", "BAT-", and ground port of the battery terminal shall be matched exactly when wiring.</p> <ol style="list-style-type: none"> 1. Please make sure that the cable cores are fully connected to the terminal wiring holes and not exposed. 2. Please make sure the cable is connected tightly, otherwise the terminal may overheat when the equipment is running and cause damage to the equipment.
--	---

The PV connection is the same as the battery connection, only with different plastic case and metal core.

Please refer to Figure 6.2 for the specific procedure of wire pressing.

Step 1: Please select the appropriate cable type and specification according to Table 6-1, find the corresponding PV and BAT terminals based on table 3-1, and strip the insulation layer of the positive and negative cables to the appropriate length with wire stripping pliers.

Step 2: Insert the positive and negative cables stripped of insulation into the PV/BAT corresponding positive and negative metal terminals respectively, and crimp the cables with the metal cores of the terminals using crimping pliers to ensure that the cable wires are firmly crimped to the metal cores;

Step 3: Insert the crimped positive and negative cables through the locknuts and into the corresponding plastic housing of the PV/BAT until a click is heard, indicating that the metal core has been snapped into place, after which the locknuts are tightened;

Step 4: Check if the PV/BAT positive and negative terminals are connected incorrectly using a multi-meter, and after confirming that they are correct, they can be inserted into the corresponding PV/BAT input terminals;

Tip: Please make sure the PV/BAT positive and negative connectors are disconnected from the top of the inverter if you need to remove them, then use the removal wrench to insert the fixing tabs and press down firmly to remove the connectors.

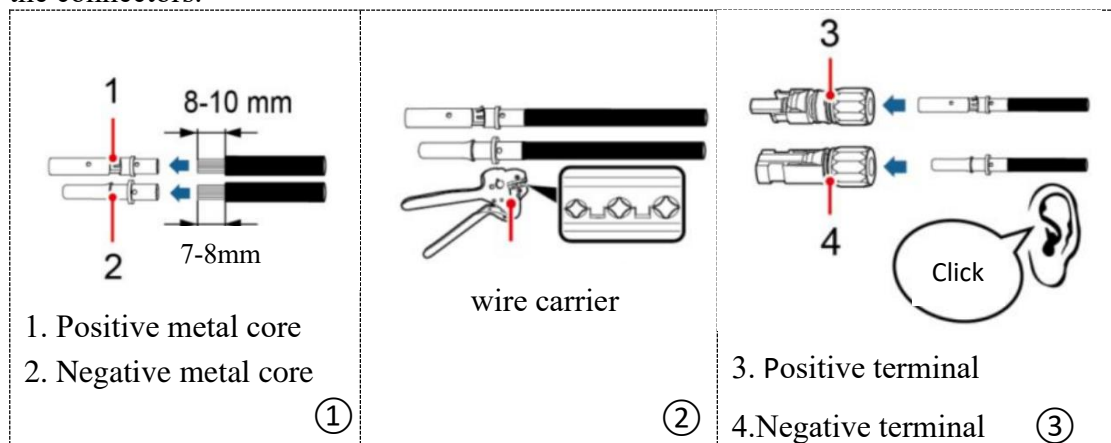

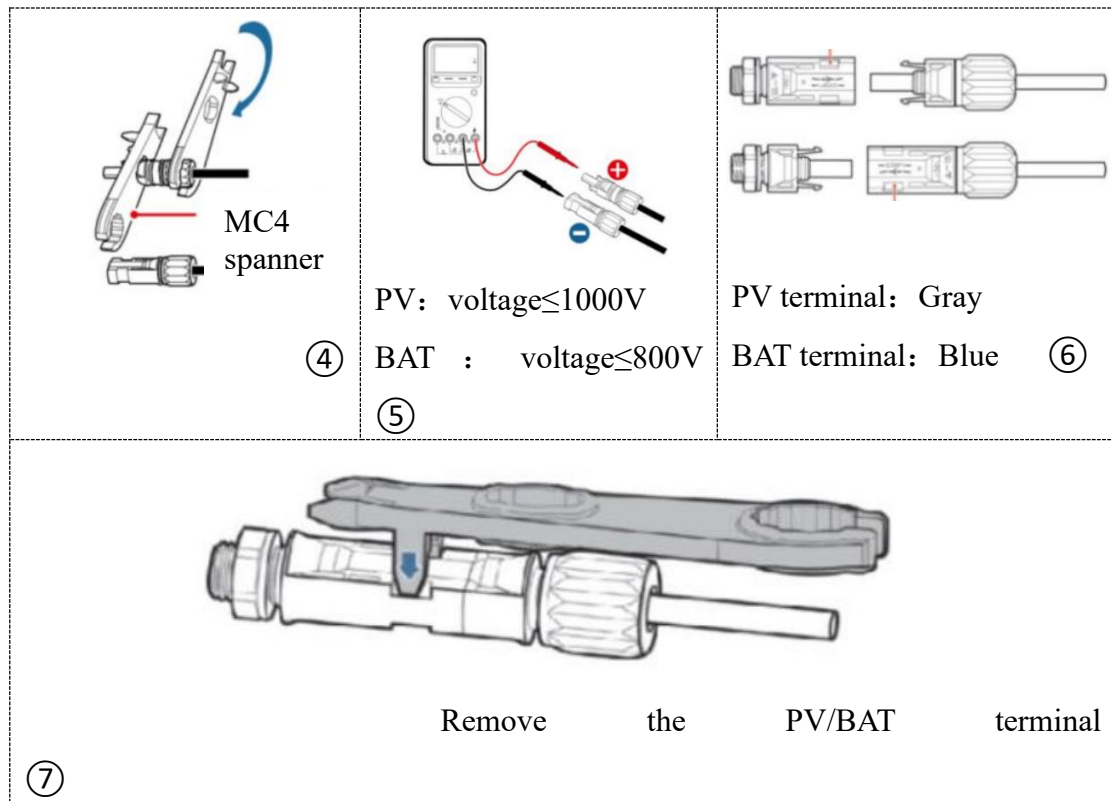

Figure 6.2 Connect PV&BAT cables

The PV modules used to connect to this inverter shall meet the requirements of the Class A standard for IEC 61730 certification, and the maximum current allowed through the external circuit breaker for each PV string and battery input shall be greater than or equal to 32A.

6.4 Connect the AC grid connection cable

 Warning	<p>When wiring, the "L1", "L2", "L3", "N", and grounding ports of the AC line and AC terminal shall be completely matched. If the cable connection is incorrect, it will cause equipment damage.</p> <ol style="list-style-type: none"> 1. Please make sure that the cable cores are fully connected to the terminal wiring holes and not exposed. 2 Please make sure the insulation board at the AC terminal is stuck tightly and not loose. 3 Please make sure the cable connection is tight, otherwise the terminal may be overheated when the equipment is running causing damage to the equipment.
--------------------	--

Please find the corresponding AC grid connection terminals according to Table 3-1.

For details about cable connections, see figure 6.3

Step 1: Please select the appropriate cable type and specification according to Table 6-1, and strip the cable insulation with wire stripping pliers to the appropriate length, after which the cable will be passed through each part of the terminal.

Step 2: Lock the stripped insulation layer of the cable in the lock hole on the terminal according to the L1, L2, L3, N, PE markings on the terminal, and tighten the

lock nut clockwise with an Allen wrench to ensure that the cable is firmly connected.

Step 3: Connect the AC grid connection terminal to the grid connection board port on the inverter, rotate the terminal clockwise and check the tight connection between them.

The maximum current allowed to pass through the circuit breaker used for grid over connection shall be greater than or equal to 63A.

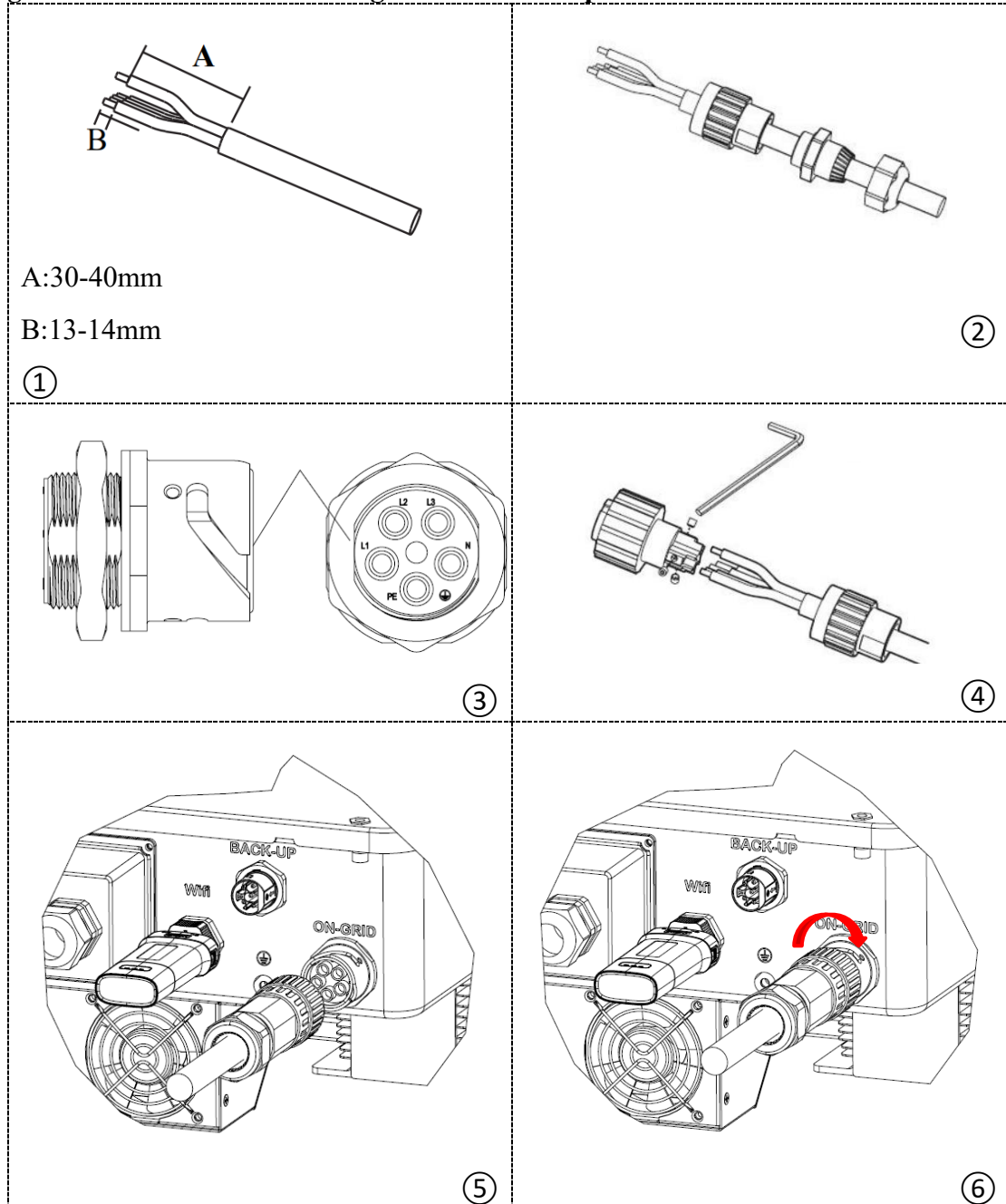

Figure 6.3 AC Parallel Cable Connection

6.5 Connect the AC load cable

Please find the corresponding AC load terminals according to Table 3-1.

For details about cable connections, see figure 6.4

Step 1: Please select the appropriate cable type and specification according to Table 6-1, and strip the cable insulation with wire stripping pliers to the appropriate length, after which the cable will be passed through each part of the terminal.

Step 2: Lock the stripped insulation layer of the cable in the lock hole on the terminal according to the L1, L2, L3, N, PE markings on the terminal, and tighten the lock nut clockwise with a 4mm cross-head screwdriver to ensure that the cable is firmly connected.

Step 3: Connected the AC off-grid terminal to the off-grid cable board port on the inverter, turn the terminal clockwise, insert the inverter load female port, use an 4mm phillips screwdriver to tighten the screws on the top of the male load terminal clockwise and check that the connection between the terminals.

The maximum current allowed to pass through the circuit breaker used for off-grid load over the external one shall be greater than or equal to 40A.

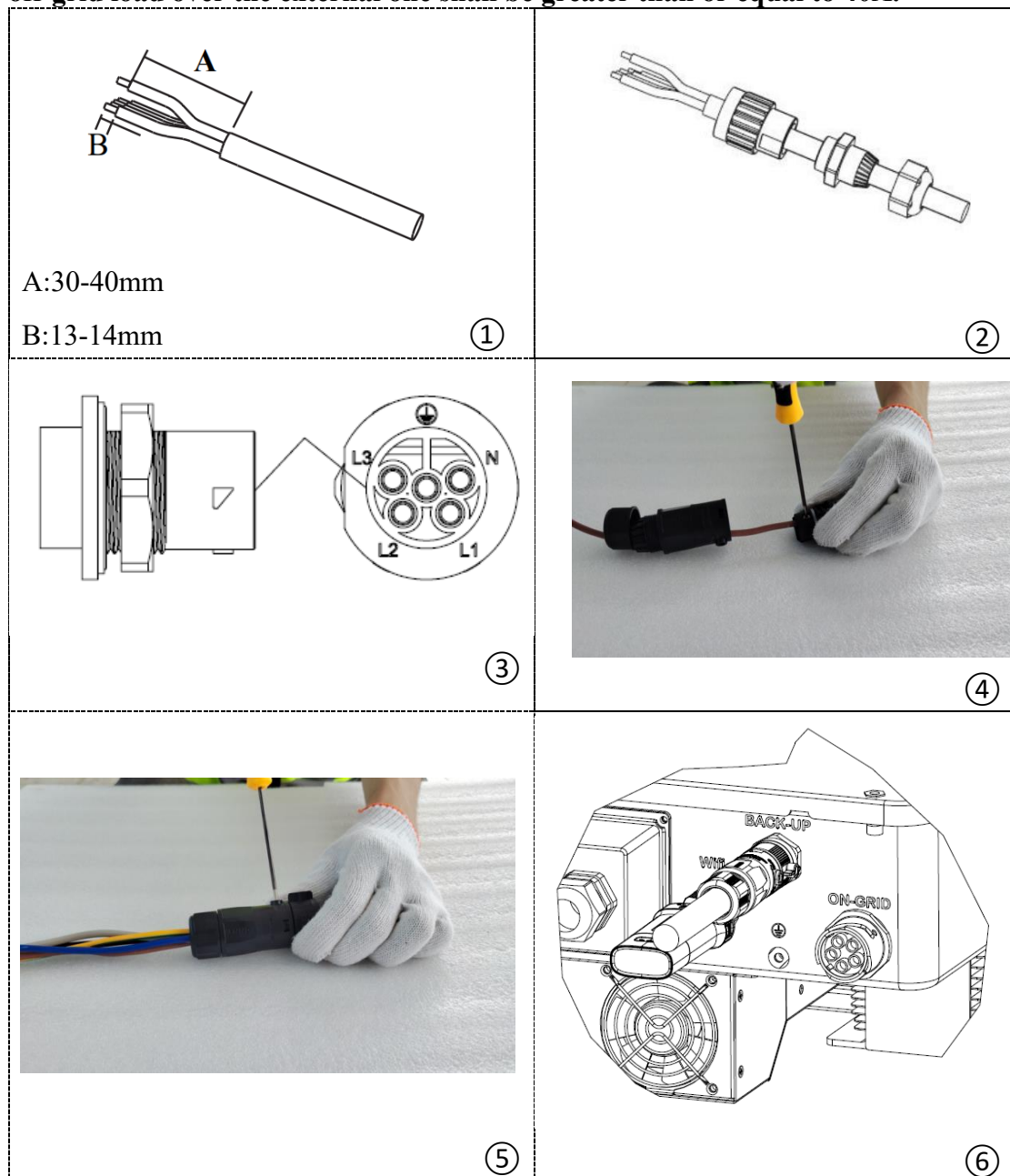

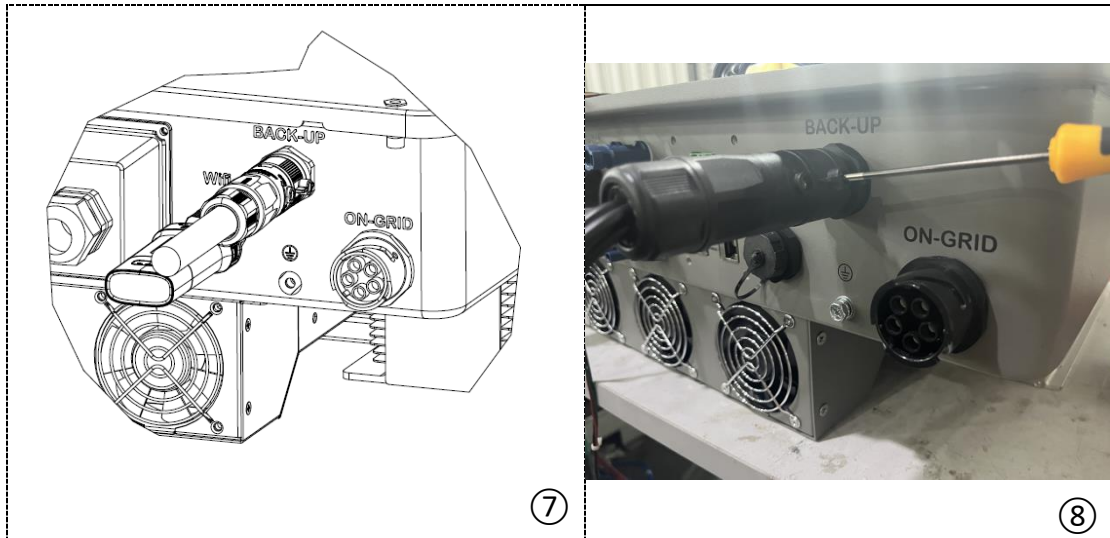

Figure 6.4 AC load cable connection

6.6 Protective ground wire connection



Attention

Since the inverter is transformerless, it is required that both positive and negative terminals of the PV array shall not be grounded, otherwise it will cause inverter failure. All non-current carrying metal parts (such as bracket, distribution cabinet shell, inverter shell, etc.) shall be connected to the ground in the PV power system.

Prepare the grounding cable

Step 1: Strip the insulation of the grounding cable to the proper length with wire stripping pliers

Step 2: Strip the insulation of the wire core through the terminal conductor pressure welding area, and crimp with crimping pliers. Recommended OT terminal: OTM6, with a recommended ground wire diameter of 6 mm² yellow-green outdoor power cable.

Step 3: Fix the OT terminal with M6 screws at the position shown in Figure 6.5 ③, and the locking torque is recommended to be 5N · m.

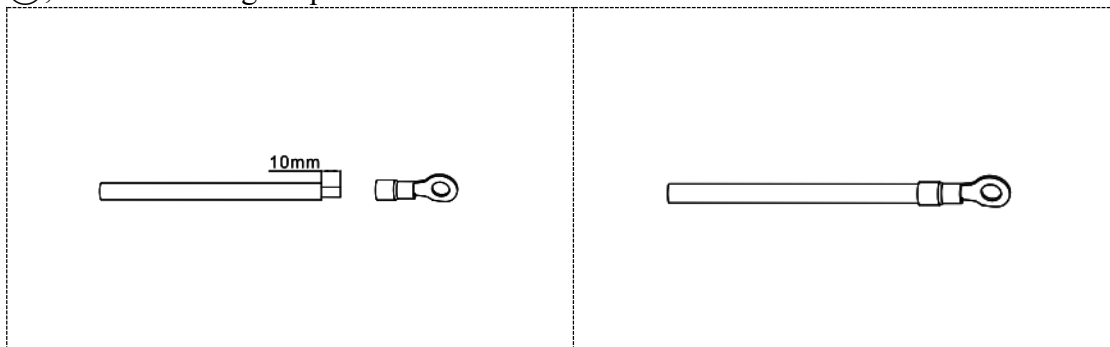

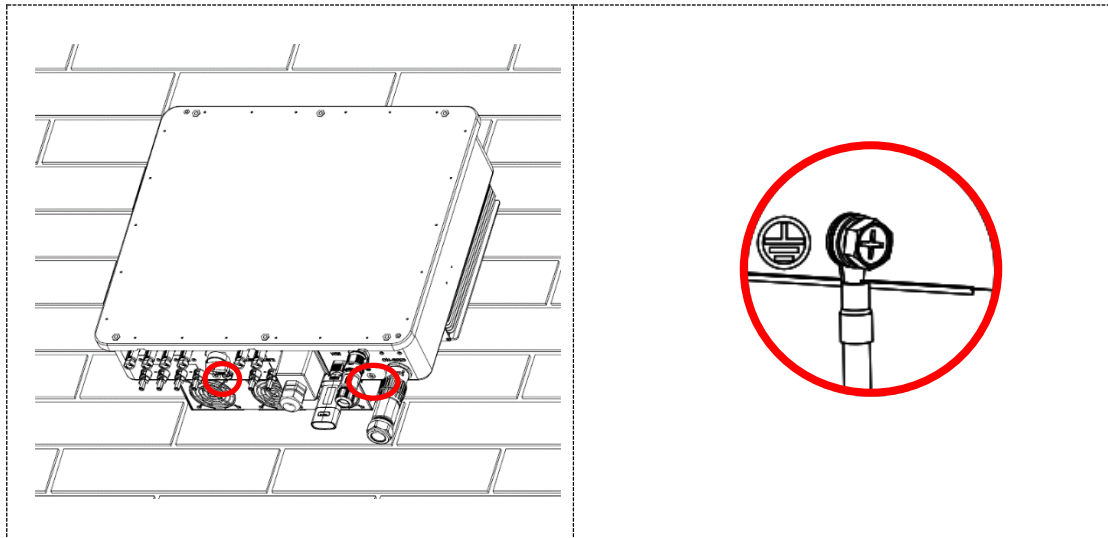

Figure 6.5 Schematic diagram of protective grounding

6.7 WIFI communication interface connection (optional)

WIFI is an external accessory and needs to be optional by the user.

Please find the corresponding WIFI external stick according to Table 3-1, plug it into the interface as shown in Figure 6.6, and then you can connect WIFI with the inverter by cell phone APP "SolarAll-H" after power on.

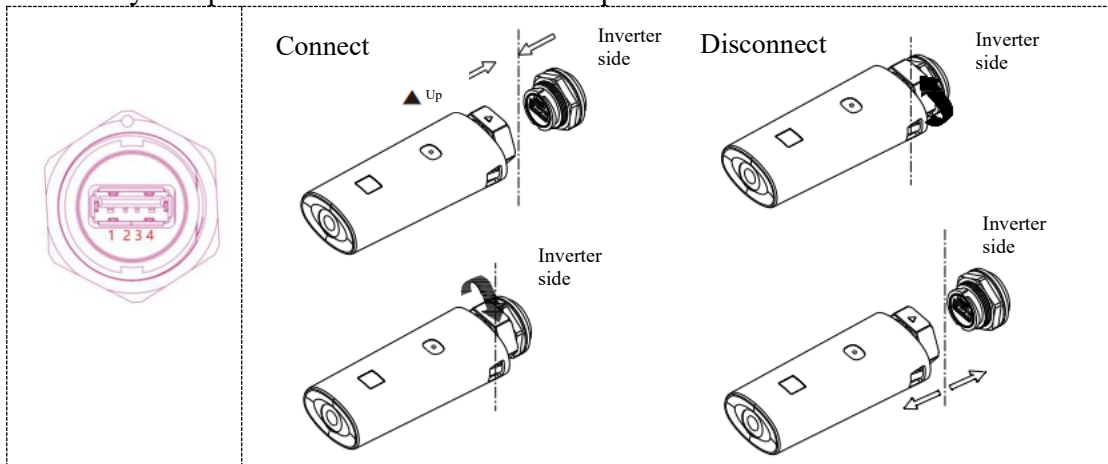

Figure 6.6 WIFI interface, Connection and Disconnection

6.8 X1 board communication port connection

The X1 board is a multi-function communication port board, including meter communication, BMS communication, DRMS, parallel communication and external dry contact signal.

Step 1: Pass the cables through the waterproof cover of the signal interface and their waterproof plugs, and crimp the RJ45 terminals in the sequence of pins.

Step 2: Insert the cable into the inverter communication interface.

Step 3: Tighten the waterproof cover plate with screws.

Step 4: Tighten the waterproof nut.

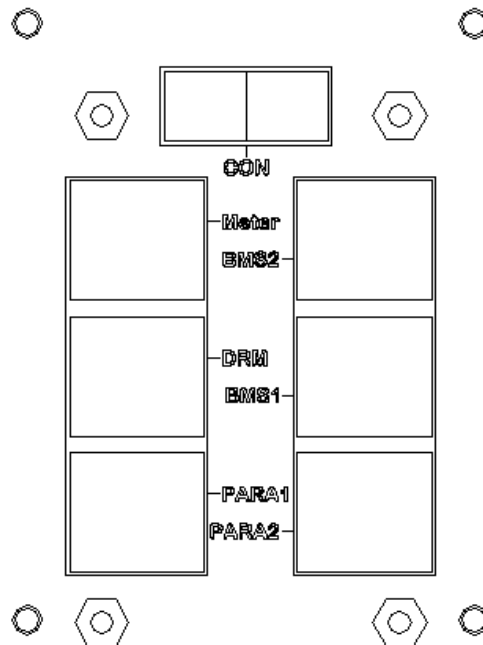

Figure 6.7 X1 board interface diagram

The RJ45 pins of the communications cables are as below:

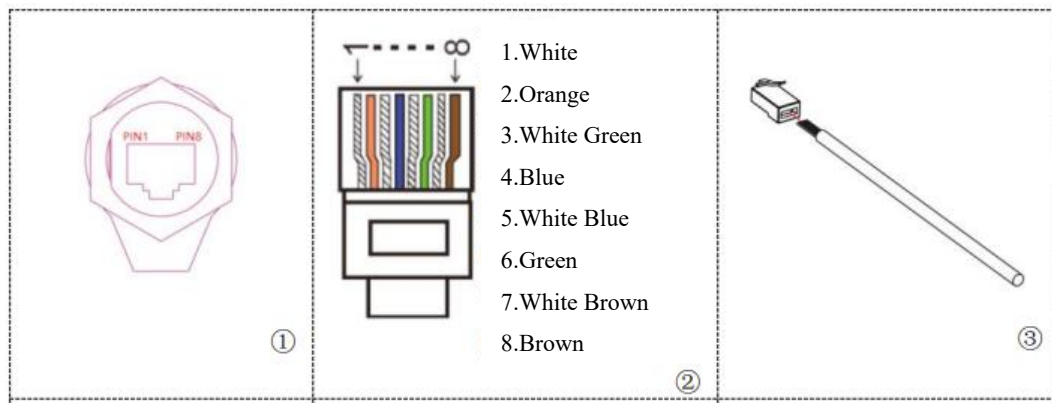

Figure 6.8 RJ45 crystal terminal wire sequence diagram

6.8.1 Smart meter connection

1, 2, 3 and 4 on the smart meter are connected to L1, L2, L3 and N of the grid respectively.

Current measurement needs to be connected with current transformers. 5 and 6 on the smart meter are connected to the positive and negative leads of the current transformers, and then the current transformers are fastened as the L1 phase of the grid, and similarly, 7 and 8 are connected to the L2 phase and 9 and 10 are connected to the

L3 phase. 12 and 13 on the meter are connected to any one phase of AC and N line.

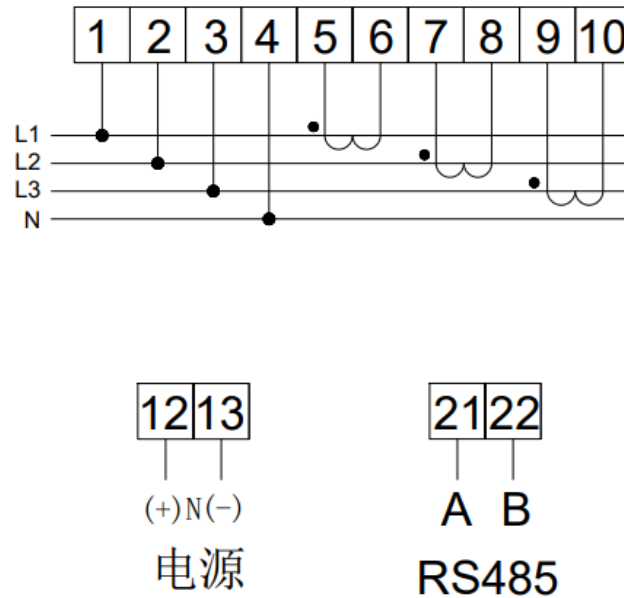

Figure 6.9 Smart meter terminal wiring description diagram

The current transformer is oriented as shown in Figure 6.10 with the arrow pointing to the grid.

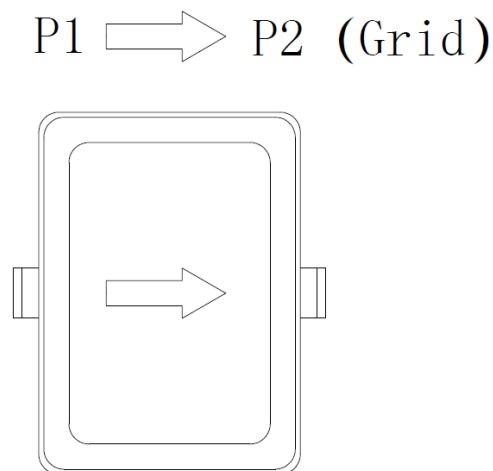

Figure 6.10 Wiring direction of current transformer

According to table 6-2,21 corresponding to RS485-A and 22 corresponding to RS485-B on the smart meter are connected to the 8 and 7 ports of the network terminal,

then connect the communication line to the corresponding meter port shown in Figure 6.7.

Table 6-2 Description of smart meter ports

PIN	Color	Definition	Function	Note
1-6	/	/	/	/
7	White & Brown	RS485_B_EEM	RS485 differential signal B	Smart meter communication
8	Brown	RS485_A_EEM	RS485 differential signal A	
9-12	/	/	/	/

6.8.2 BMS communication line connection

Please crimp the network cable terminals according to the instructions in Table 6-3 and Figure 6.8.

Table 6-3 Description of the BMS1 interface

PIN	Color	Definition	Function	Note
1	White & Orange	RS485-A1-BMS	RS485 differential signal A1	Communication with lithium battery BMS, the inverter can be adaptive to BMS to provide CAN and RS485 communication
2	Orange	RS485-B1-BMS	RS485 differential signal B2	
4	White & Green	CANA-H1-BMS	CAN high level data	
5	Blue	CANA-L1-BMS	CAN low level data	
3、6-12	/	/	/	

Table 6-4 Description of the BMS2 interface

PIN	Color	Definition	Function	Note
1	White & Orange	RS485-A2-BMS	RS485 differential signal A2	Communication with lithium

2	Orange	RS485-B2-BMS	RS485 differential signal B2	battery BMS, the inverter can be adaptive to BMS to provide CAN and RS485 communication
4	White&Green	CANA-H2-BMS	CAN high level data	
5	Blue	CANA-L2-BMS	CAN low level data	
3、6-12	/	/	/	/

6.8.3 DRMS logic interface connection

Crimp the network cable terminals according to Table 6-4 and Figure 6.9.

Table 6-5 Description of DRMS ports

PIN	Color	Definition	Function	Note
1	White&Orange	DRM1/5	The DRMS interface is applicable to the Australian AS-NZS-4777.2 (some European requirements) safety standard	DRMS logical interface
2	Orange	DRM2/6		
3	White&Green	DRM3/7		
4	Blue	DRM4/8		
5	White&Blue	REF GEN		
6	Green	COM LOAD		
7-12	/	/	/	/

6.8.4 Parallel communication line connection

If there are multiple inverter in use and need to use parallel inverter for communication, you need to use the network cable terminal to connect to Pa1 of the first inverter, the other end to Pa2 of the second inverter, and so on, Table 6-5 describes the signals of the communication cables. Figure 6.11 shows the connections.

Table 6-6 Description of parallel ports

PIN	Color	LINK1 Definition	LINK1 Definition	Note
-----	-------	------------------	------------------	------

1	White&Orange	CON1_AO	CON2_AO	Parallel signal
2	Orange	CON1_AO	CON2_BO	
3	White&Green	CON1_AI	CON2_AI	
4	Blue	CON1_BI	CON2_BI	
5-6	/	/	/	/
7	White&Brown	CON_SyncH	CON_SyncH	Parallel synchronization signal
8	Brown	CON_SyncL	CON_SyncL	
9-12	/	/	/	/

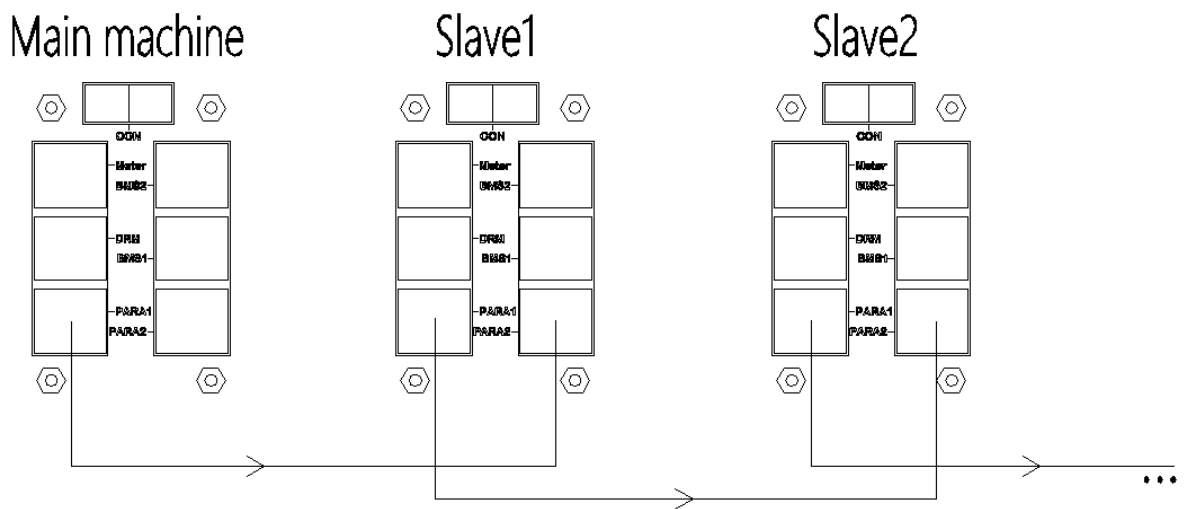

Figure 6.11 Parallel connection diagram

The parallel communication sequence is shown in Figure 6.12.

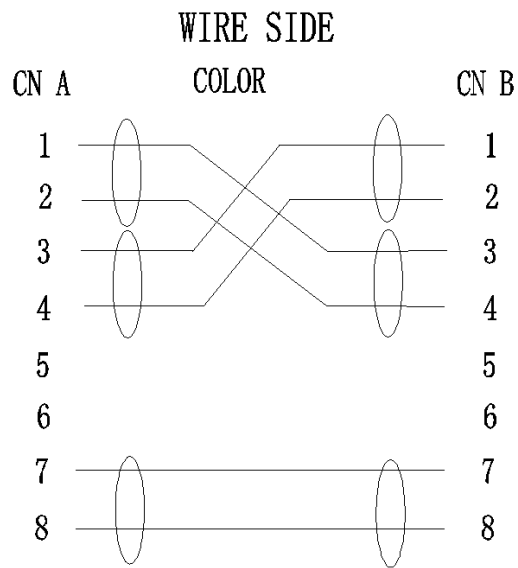

Figure 6.12 Parallel communication line sequence diagram

Application precautions:

1. Support maximum of 15 three phase hybrid inverter parallel.
2. Ensure that the inverter is connected to the link port cable.
3. Ensure That the load power is less than the maximum power of parallel inverter.

6.8.5 Introduction to dry contacts

Figure 6.7 shows the locations of dry contact ports.

Table 6-7 Description of dry contacts

	PIN	Definition	Note
Dry contact 1	2	OP1_NO	External dry contact port
	4	OP1_COM	
Dry contact 1	1	OP2_NO	
	3	OP2_COM	
/	5-6	/	/

7 Equipment commissioning

7.1 Inspection before power-on

Number	Item
1	Whether the inverter is firmly fixed on the wall mounting bracket.
2	Whether the cable ties meet the alignment requirements, are reasonably distributed, and are not broken.
3	Whether the PV+/PV- and BAT+/BAT- wires are firmly connected, the polarity is correct, and the voltage is in accordance with the accessible range.
4	Whether the DC switch is properly connected between the battery and inverter, and whether the DC switch is disconnected.
5	Whether the AC circuit breaker is properly connected between the inverter grid port and the grid, and the circuit breaker is disconnected.
6	Whether the AC circuit breaker is properly connected between the inverter load port and the grid, and the circuit breaker is disconnected.
7	Please make sure the communication cable is properly connected for batteries.

7.2 Initial power-on of equipment

Please be sure to follow the steps below to turn on the inverter.

1. Close the AC circuit breaker between the inverter grid port and the grid;
2. Close the AC circuit breaker between the inverter load port and the emergency load;
3. Turn on the PV switch (when connected to the PV);
4. Turn on the battery and close the DC switch between the battery and the inverter;
5. Start operation after successful self-check of the inverter.

8. System debugging (WiFi stick is optional)

8.1 Indicator description

The bar indicator light in the middle of the device panel indicates the inverter status in red, green, and blue colors.



Table 8-1 Indicator Status Description

Status	Indicator Light		
	Green	Blue	Red
Standby	Flashing (1s once)		
Grid-connected PV	Normally on		
Grid-connected-BAT	Normally on		
Grid-connected-BAT&PV	Normally on		
Off-grid-PV		Normally on	
Off-grid-BAT		Normally on	
Off-grid-BAT&PV		Normally on	
Alarm (no shutdown or power down)			Slow flash (2s once) When PV low voltage no flash
Recoverable fault (DCDC or INV shutdown)			Fast flash (0.5s once)
Non-recoverable fault (DCDC or INV shutdown)			Normally on

8.2 Inverter parameters setting via APP

8.2.1 Software Acquisition

For Android users, "ESS LINK" can be downloaded from different Android stores. For IOS users, the "ESS LINK" App can be downloaded from the App Store.

8.2.2 User registration and login

Click to enter "ESS LINK" App, users need to register for the first time. click "Register" at the bottom of the login screen to enter the registration screen, use your mobile number to register, enter the verification code and set the login password, then return to the login interface to log in with the newly registered mobile phone number and set password, the login succeeds.

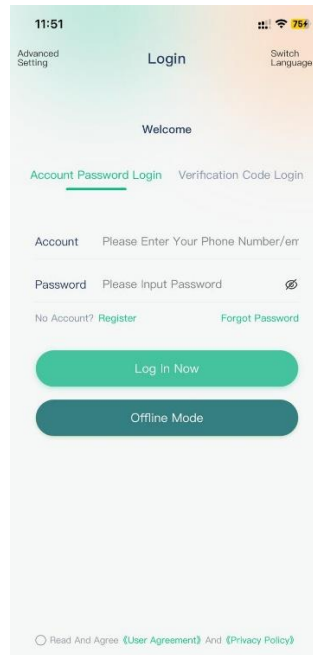

8.2.3 Add inverter information and hotspot connection

Enter the APP, click "To Add A Inverter" on the home page to enter the inverter list, add inverter by entering the PIN code on the stick or scanning the QR code on the WIFI stick, the page for filing in inverter installation information is displayed, users need to fill in the purchase date, installation date, installation unit, installation location, acceptance date and operation date information.

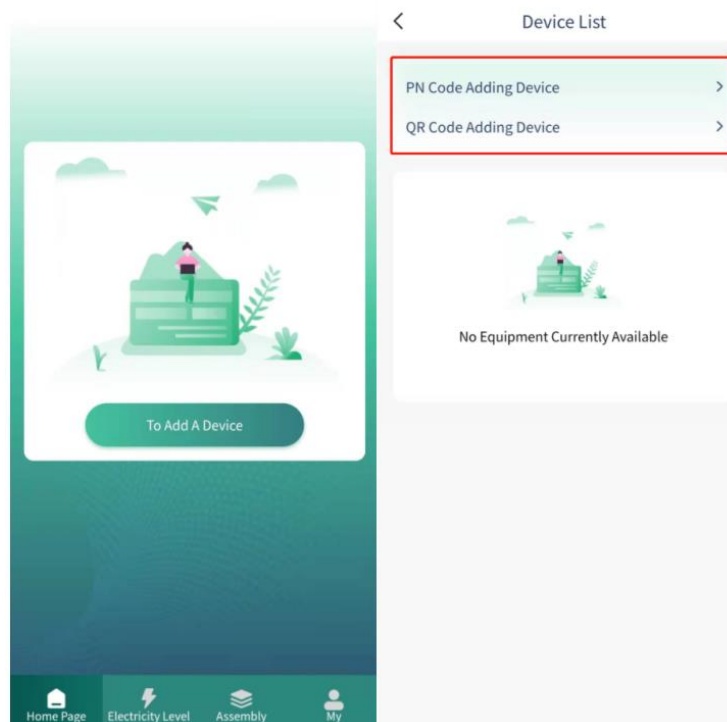

After you have filled it all out, turn on your phone's bluetooth and location info, click

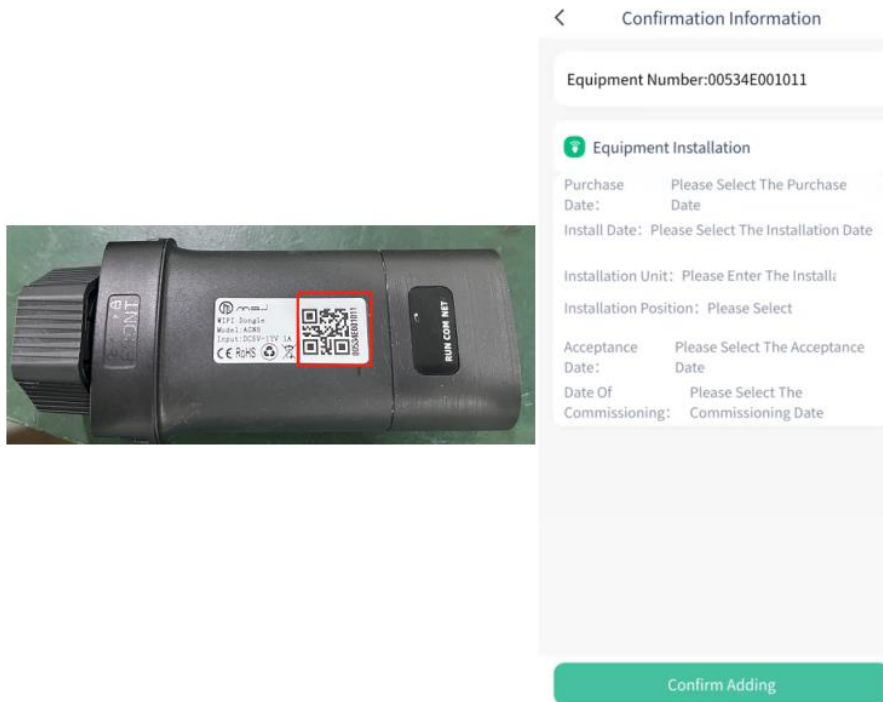

"Ok&add", the bluetooth network configuration page is displayed, after the mobile search is successful, users can fill in the home WIFI name and password or custom hotspot name and password. (users need to use the mobile phone to manually open the hotspot)

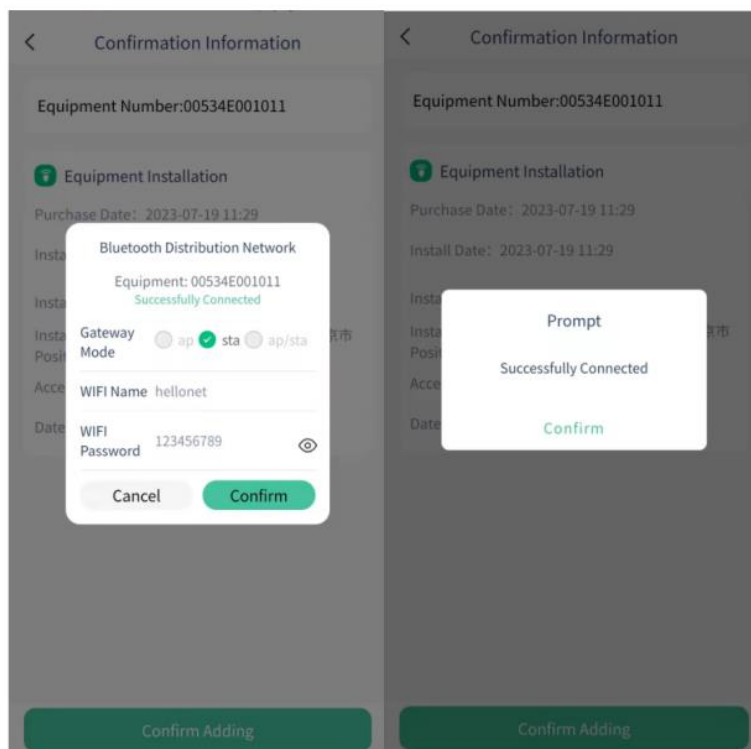

After the connection is successful, the user chooses to fill in the settings until all information is completed. This is the end of adding inverter.

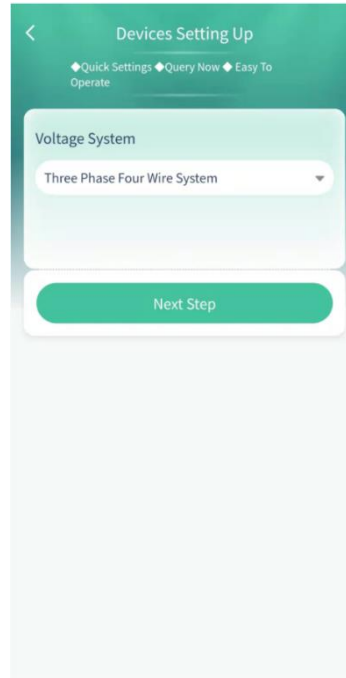

Go to the home page and click the "My" button in the navigation bar at the bottom of App interface.

Step 1: Click on "Language Settings" to set the desired language type.

Step 2: Click on "My Device" and observe if the connection to the App and inverter is successful. If there is no inverter information, check the connection between the

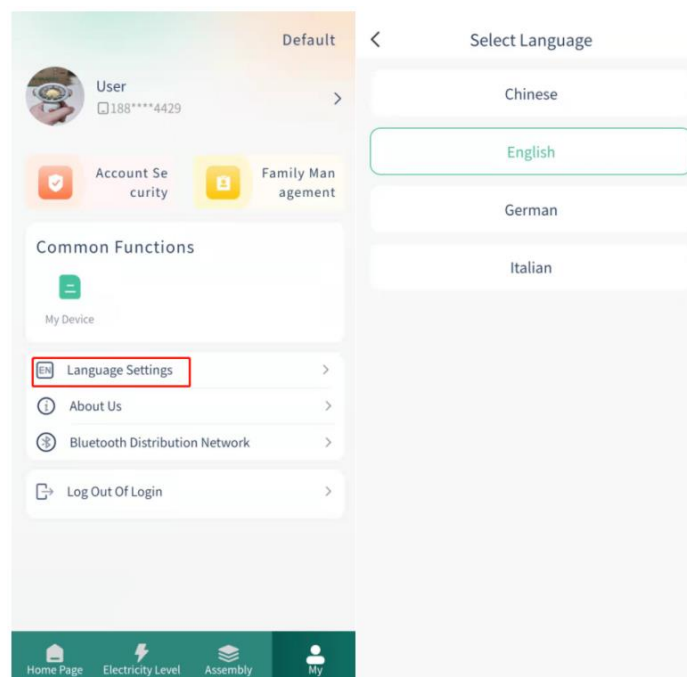

mobile APP and WIFI and repeat the above operation.

8.2.4 Home page

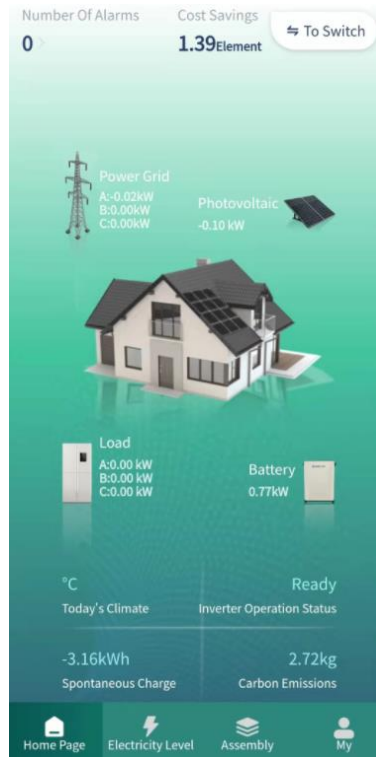

The App homepage can monitor the operating status and power of each unit of the three phase hybrid inverter, display the accumulated power generation, operating status, carbon emissions, cost savings, alarm information, and local weather.

8.2.5 Alarm Information

After connecting the inverter to the App, if the inverter experiences alarm, the current numbers of alarms will be displayed in the upper left corner of the homepage; If there are no alarms, the number of alarms will display 0. If an alarm message appears, click on the number of alarms to jump to the alarm page. The alarm interface includes current alarms, historical alarms, and all alarm information.

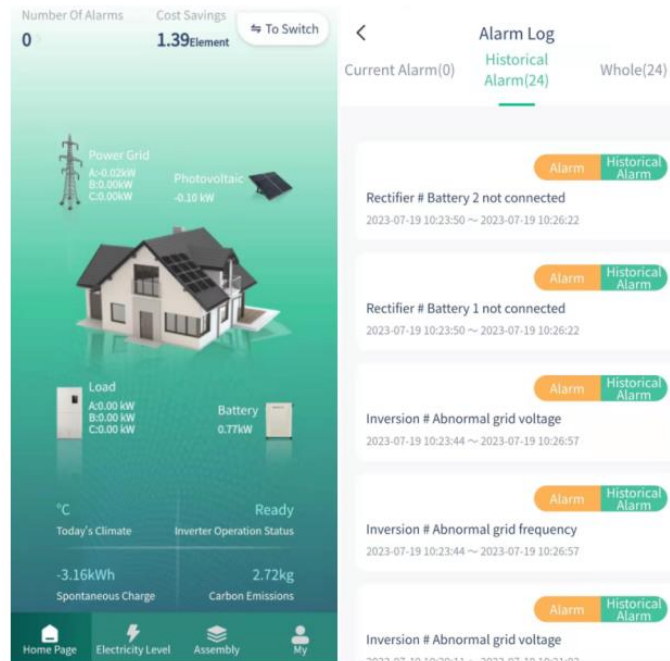

8.2.6 Energy Statistics

Click the "Power" button on the navigation bar at the bottom of the App interface to monitor the recent power consumption, current battery power and electricity price, and use the curve chart to display per current day, per month, per year and the total power generation and feed-in power.

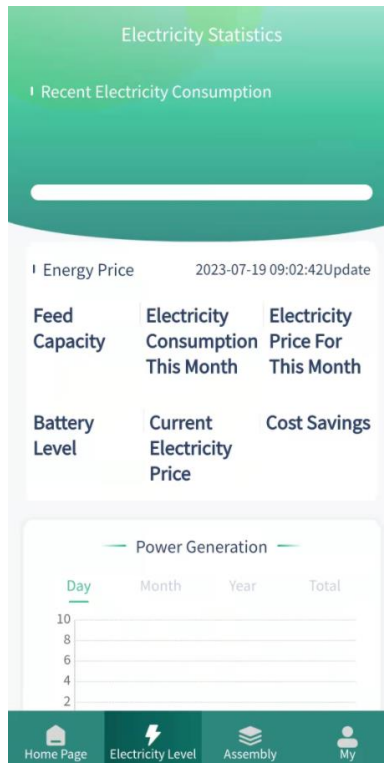

8.2.7 PV/Battery Status

Click the "Component" button on the navigation bar below the APP interface to monitor the photovoltaic panel, smart meter and battery related information.

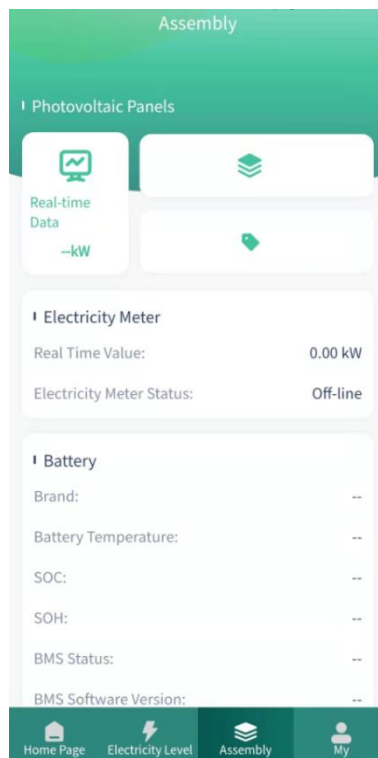

8.2.8 Settings

Click the "Me" button on the navigation bar , select "My inverter", jump to the "My Inverter" interface, click the inverter information, and jump to the "Basic Infor" interface.

Click the "... " button in the upper right corner to display a list of options, including inverter parameter settings, measurement data, version information, historical data, and operation records.

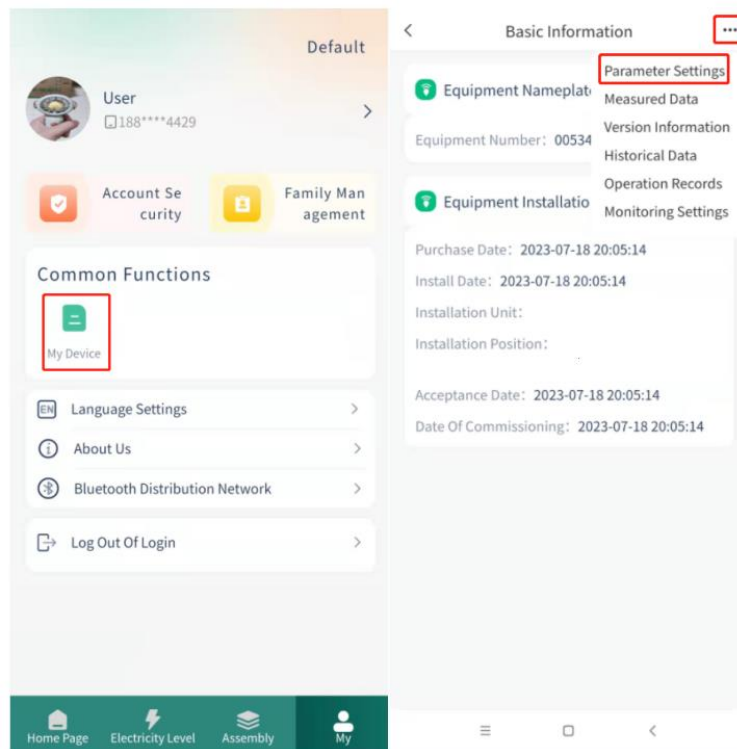

Click on "Settings" to jump to the settings interface, which mainly includes host settings, battery settings, and other settings.

1. Host Settings

The host settings include Power-On/Off setting, DRED setting, working mode setting, on-off grid switch-over setting, grid voltage&frequency setting, etc.

Power On/Off setting

Click on "Power On" to control the inverter switch on/off. After the switch on, the button will turn into green. Before starting up, it is necessary to ensure that the working mode and parameters match the current system state.

Working mode settings

Click on "Work Mode Settings" to enter the selection interface, which includes Self-use Mode, Time-of-use Mode, Disaster Recovery Mode, Off-grid Mode and set timing Mode

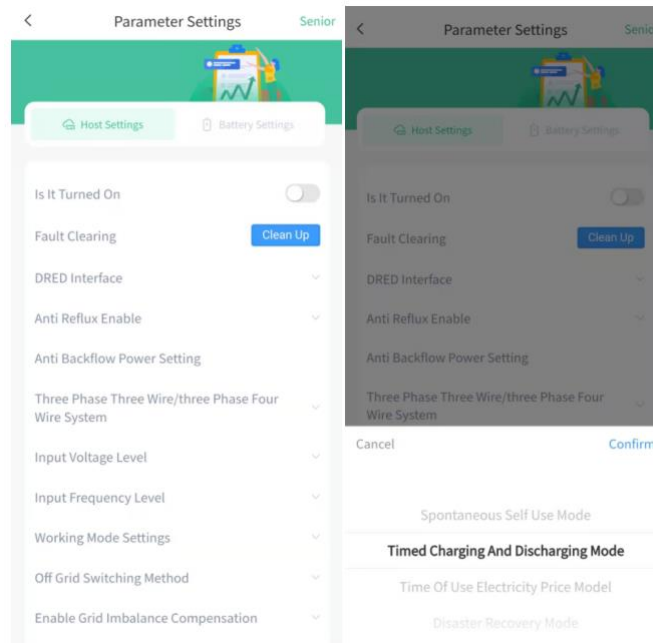

2. Battery settings

Battery settings include selection of battery quantity, selection of photovoltaic input quantity, battery type, battery voltage, and maximum charging&discharging current settings.

3. Advanced Settings

Click on the upper right corner to enter "Advanced Settings", where is for the system control settings. This interface is for debugging purposes, for professional technician ONLY and users are not allowed to set it.

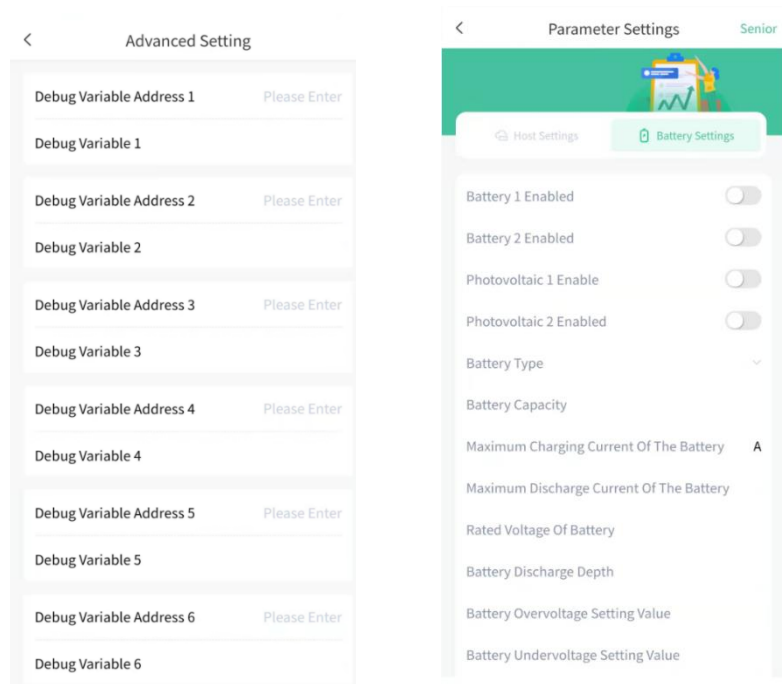

8.2.9 System Data

In the basic information interface, select "Measured Data" to jump to the parameter measurement data interface, which includes power grid, load, inverter, photovoltaic panel, others, smart meter, battery cabinet, and other settings.

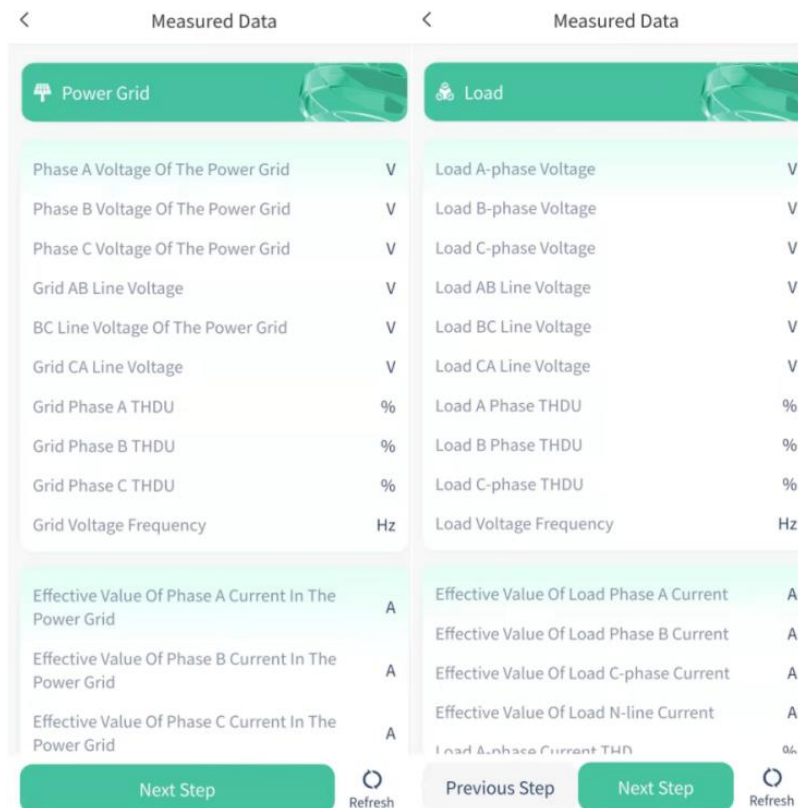
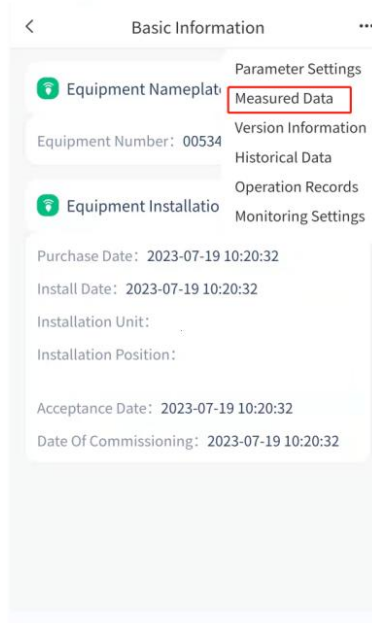

Grid and load data

Measured Data		Measured Data	
Inversion		Photovoltaic Panels	
Inverter A-phase Voltage	V	Photovoltaic Voltage 1	V
Inverted B-phase Voltage	V	Photovoltaic Current 1	A
Inverted C-phase Voltage	V	Photovoltaic Power 1	KW
Inverted AB Line Voltage	V	Photovoltaic Voltage 2	V
Inverted BC Line Voltage	V	Photovoltaic Current 2	A
Inverter CA Line Voltage	V	Photovoltaic Power 2	KW
Inverter A-phase THDU	%	Battery Voltage 1	V
Inverter B-phase THDU	%	Battery Current 1	A
Inverter C-phase THDU	%	Battery Power 1	KW
Inverter Voltage Frequency	Hz	Battery Full Capacity Percentage 1	%
Effective Value Of Inverter Phase A Current	A	Battery Full Load Support Time 1	H
Effective Value Of Inverter Phase B Current	A	Battery Voltage 2	V
Effective Value Of Inverter C-phase Current	A	Battery Current 2	A
Effective Value Of Inverter N-line Current	A	Battery Power 2	KW
Inverter A-phase Current THDU	%	Battery Full Capacity Percentage 2	%
Previous Step	Next Step	Previous Step	Next Step
	Refresh		Refresh

Inverter and PV data

Measured Data		Measured Data	
Other		Electricity Meter	
0°C	0°C	Electricity Meter Operation Status	
Temperature 1	Temperature 2	Basic State	
0°C	0°C	Cycle Period	
Temperature 4	Temperature 5	Phase A Voltage Of Electric Meter	V
Positive DC Bus Voltage	0 V	Phase B Voltage Of Electric Meter	V
Negative DC Bus Voltage	0 V	C-phase Voltage Of Electric Meter	V
Date	0-0-0 0:0:0	Phase A Current Of The Meter	A
Debug Variable 1	0	Phase B Current Of The Meter	A
Debug Variable 2	0	Meter C-phase Current	A
Debug Variable 3	0	Apparent Power Of Phase A Of Electricity Meter	KVA
Debug Variable 4	0	Electric Meter B Phase Apparent Power	KVA
Debug Variable 5	0	Phase C Apparent Power Of Electricity Meter	KVA
Debug Variable 6	0	Active Power Of Phase A Of Electricity Meter	KW
		Active Power Of Phase B Of Electricity Meter	KW
Previous Step	Next Step	Previous Step	Next Step
	Refresh		Refresh

System temperature and smart meter data

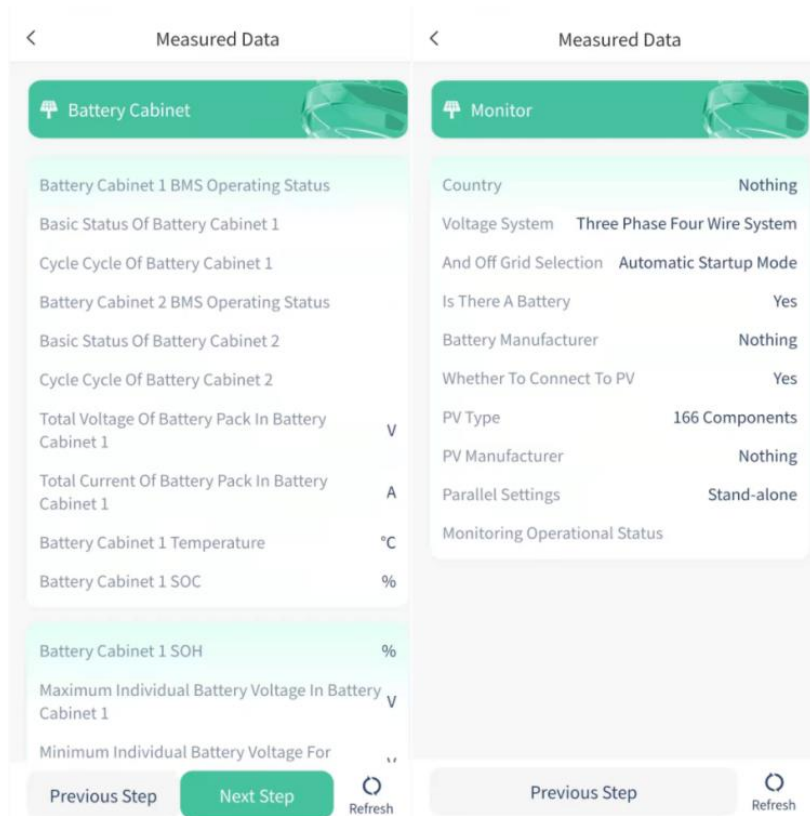

Battery and monitoring data

8.2.10 Version Information

The version information includes the current software version of DCDC, DCAC,

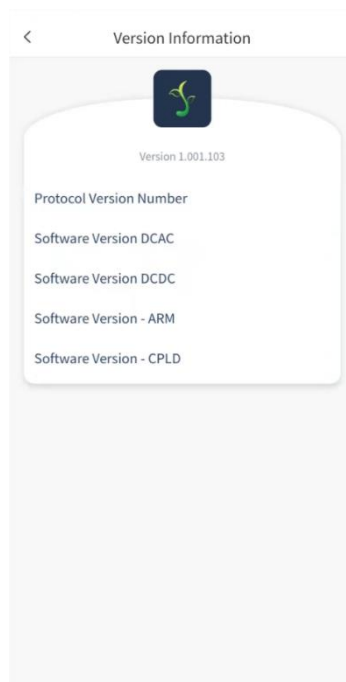

CPLD, and ARM.

8.2.11 Operation Records

Record the name, occurrence time, and numerical changes of the operation.



Parameter Level	System Settings
Parameter Name	Fault Clearing
Time Of Occurrence	2023-07-19 10:03:19
Value Change	0.0-->1
Parameter Level	System Settings
Parameter Name	Fault Clearing
Time Of Occurrence	2023-07-19 09:40:52
Value Change	1.0-->1
Parameter Level	System Settings
Parameter Name	Fault Clearing
Time Of Occurrence	2023-07-18 20:06:46
Value Change	1.0-->1
Parameter Level	System Settings
Parameter Name	Fault Clearing
Time Of Occurrence	2023-07-17 17:21:32
Value Change	
Parameter Level	System Settings
Parameter Name	Fault Clearing
Time Of Occurrence	2023-07-17 17:04:16
Value Change	

No More Data

9. Troubleshooting and maintenance

This section will find the cause of any issues in inverter.

9.1 App alarm display and solution

Table 9-1 Fault Message List and Solution

Series No.	Fault name	Solutions
1	Abnormal grid voltage	It may be a grid abnormal if it occasionally alarms. The inverter will automatically return to normal after the grid is restored to normal; check if the grid voltage/frequency is within the acceptable range if the alarm is frequent, if so, check the AC circuit breaker and AC wiring of the inverter, if correct, the alarm will be automatically cleared after the grid is restored to normal status
2	Abnormal grid frequency	
3	Reverse sequence of grid voltage	
4	phase loss in grid voltage	
5	Excessively high temperature in heat sink	Please make sure the inverter is installed in a place without direct sunlight, and keep the heat sink temperature below 50°C for 5min, and the alarm will be cleared automatically.
6	Insulation fault	Check the impedance of PV string to the ground protection ground, it is normal to have a resistance value greater than 50kΩ, if the resistance value is less than 50kΩ, please check the short circuit point and rectify it; check whether the ground protection of the inverter is connected correctly. If there are no abnormal alarms in power-on detection, it will be cleared automatically or a fault clear command will be sent
7	Leakage protection fault	Check if there is any issue with inverter or wiring, send fault clear command to re-test if there is no issue.
8	Auxiliary power fault	Inverter automatically detects and clears the alarm automatically after 20ms.
9	Fan fault	Please check whether the fan is blocked or intact, and the alarm will be cleared automatically after 2s of normal operation
10	Lightning arrester abnormality	The alarm will be cleared automatically after the lightning arrester works normally
11	Battery 1 not connected	Please check if battery 1 is connected correctly or if the voltage is abnormal, after confirming it is correct, the warning will be cleared automatically or a fault clear command will be sent
12	Battery 1 overvoltage	
13	Battery 1 under voltage	
14	Battery 1 discharge termination	
15	Battery 1 reverse connection	
16	Battery 2 not connected	Please check if battery 2 is connected correctly or if the voltage is abnormal, once confirmed it is correct, the

17	Battery 2 overvoltage	warning will be cleared automatically or a fault clear command will be sent
18	Battery 2 under voltage	
19	Battery 2 discharge termination	
20	Battery 2 reverse connection	
21	PV1 is not connected	Please check if PV1 is connected correctly or if the voltage is abnormal, once confirmed it is correct, the warning will be cleared automatically or a fault clear command will be sent
22	PV1 overvoltage	
23	PV2 is not connected	Please check if PV2 is connected correctly or if the voltage is abnormal, once confirmed it is correct, the warning will be cleared automatically or a fault clear command will be sent
24	PV2 overvoltage	
25	DC bus overvoltage	Inverter malfunction, turn off inverter, wait 5 minutes, then turn on inverter, send fault clear command to restart,start inverter.
26	DC bus under voltage	
27	DC bus voltage unbalance	The alarm will be cleared automatically after the voltage fluctuation is kept within the allowable range for 2s
28	Inverter overload	Please check whether the inverter is working in overload state or not, and the alarm will be cleared automatically after 10min to confirm normal or send fault clear command
29	Inverter overload timeout	
30	Battery 1 overload timeout	
31	Battery 2 overload timeout	
32	PV1 overload timeout	
33	PV2 overload timeout	
34	Inverter soft start failure	Inverter malfunction, turn off inverter, wait 5 minutes, then turn on inverter, send fault clear command to restart,start inverter.
35	Battery 1 soft start failure	
36	Battery 2 soft start failure	
37	DSP1 parameter setting fault	The alarm will be cleared automatically if the parameters are set correctly
38	DSP2 parameter setting fault	
39	CPLD version compatibility fault	The alarm will be cleared automatically after version matching
40	DSP communication fault	The alarm will be cleared automatically after the SPI communication is normal

41	Relay self-check not passed	Send fault clear command to re-check
42	Inverter abnormal	This alarm will be cleared automatically after other issues are solved
43	PV1 soft start failure	Inverter malfunction, turn off inverter, wait 5 minutes, then turn on inverter, send fault clear command to restart inverter.
44	PV2 soft start failure	
45	Balanced circuit overload timeout	If no operation is performed, the fault is automatically cleared 10 minutes later or send fault clear command
46	The system runs derated	When the inverter fan fails or the internal temperature is too high, the inverter will run with reduced power. Check whether the fan is damaged or blocked. If no, this alarm is automatically cleared when the temperature is lower than 68°C.
47	Inverter relay short circuit	Inverter malfunction, turn off inverter, wait 5 minutes, then turn on inverter, send fault clear command to restart, start inverter.
48	Inverter relay is open	

9.2 Regular maintenance

 Warning	<p>Make sure that the inverter is disconnected from power. Wear personal protective equipment when operating the inverter</p>
---	---

Table 9-2 Maintenance Instructions

Maintenance content	Maintenance methods	Maintenance period
System cleaning	Check the heat sink, air inlet/outlet for foreign objects and dust.	1 time/half year~1 time/year
DC Switch	Turn the DC switch on and off 10 times continuously to ensure proper DC switch function.	1 time/year
Electrical connection	Check whether the electrical connection is loose, whether the cable appearance is broken, and whether there is copper leakage.	1 time/half year~1 time/year
Leakproofness	Check whether the equipment inlet hole sealing meets the	1 time/year

	requirements, if the gap is too large or not blocked, it needs to be resealed.	
THDI test	<p>Zref shall be added between inverter and grid in THDI test according to Australian requirements.</p> <p>L:0.24 Ω + j0.15 Ω; N:0.16 Ω +j0.10 Ω L:0.15 Ω + j0.15 Ω ; N:0.1 Ω + j0.1 Ω</p>	Depends on the requirement.

10. Technical parameters

Table 10-1 Technical Parameters Description

Product model	SolarAll-H 10000T	SolarAll-H 12000T	SolarAll-H 15000T	SolarAll-H 18000T	SolarAll-H 20000T
Battery parameter					
Number of battery input channels	2				
Battery type	Lithium batteries				
Battery voltage range	180~800V				
Full load battery voltage range	210V-800V	250V-800V	300-800V	360-800V	400V-800V
Maximum charge and discharge current	50A (25A/25A)				
Peak charge/discharge current&duration	70A (35A/35A)-60s				
Nominal charge/discharge power	10000W	12000W	15000W	18000W	20000W
Communication Interface	RS485/CAN				
PV input parameters					
Number of PV input channels	2				
Maximum input power	15000WP (7500WP/7500WP)	18000WP (9000WP/9000WP)	22500WP (11250WP/11250WP)	27000WP (13500WP/13500WP)	30000WP (15000WP/15000WP)
Maximum input voltage	1000V				
MPPT voltage range	180-960V				
MPPT full load voltage range	250V-850V	290V-850V	350V-850V	410V-850V	450-850V
Starting voltage	200V				
Nominal input voltage	600V				
Maximum input current per MPPT	25A/25A				

Maximum short-circuit current per MPPT	30A/30A				
MPPT quantity	2				
Maximum input strings per MPPT	2				
Parallel input and output parameters					
Nominal output power	10000W	12000W	15000W	18000W	20000W
Maximum output power	11kVA	13.2kVA	16.5kVA	19.8kVA	22kVA
Maximum grid input power	20kVA	24kVA	30kVA	36kVA	40kVA
Maximum output current	16A	20A	24A	29A	32A
Maximum grid input current	29A	35A	44A	52A	58A
Nominal voltage	3/N/PE,220/380V,230V/400V,240V/415V				
Grid voltage range	184-276V				
Rated grid frequency	50/60Hz				
Nominal Grid frequency	45Hz-55Hz/55Hz-65Hz				
Power factor	1 (0.8 lead-0.8 lag)				
THdI(@ Nominal power)	<3%				
Off-grid output parameters					
Nominal output power	10000W	12000W	15000W	18000W	20000W
Maximum output power	11kVA-60s	13.2kVA-60s	16.5kVA-60s	19.8kVA-60s	22kVA-60s
Nominal output current	15A	18A	22.5A	27A	30A
Nominal output voltage	3/N/PE, 220/380Vac, 230/400Vac				
Nominal output frequency	50/60Hz				
Thdu(@ linear load)	<3%				
On/off-grid switch-over time	<10ms				
Efficiency					

European efficiency	97.70%
Maximum efficiency	98.20%
Maximum battery charge/discharge efficiency	97.8%
Protection	
DC Switch	Available
Input reverse	Available
Output overvoltage, overcurrent, short circuit	Available
Anti-islanding	Available
Residual current detection	Available
Insulation resistance detection	Available
Surge protection level	II
Battery input reverse connection protection	Available
Routine parameters	
Weight	35kg
Noise	<45dB
Topology	No isolation
Working altitude	<4000m
Ambient Temperature	-25°C-60°C
Ambient Humidity	5%-95%
Cooling method	Air cooling
IP Degrees	IP65
Dimensions	573*509*219mm
Standby loss	<15W

Features	
DC terminal	MC4
AC output terminal	5P connector
interface	RS485/CAN/DRED/DO/Parallel port
Human-computer interaction mode	H5/LED/APP/WIFI/4G/Bluetooth
Scalability in Parallel function	Support
Standard Warranty	5 years
Certification	
Grid	VDE-AR-N4105,VDE V 0126-1-1 G98/G99, CEI 0-21,EN 50549,NRS 097-2-1,AS 4777.2,R25
Safety regulations	IEC62109-1, IEC62109-2,EN62109-1,EN62109-2
EMC	EN61000-6-1, EN61000-6-2, EN61000-6-3, EN61000-6-4
Dry contact	Australia: DRED DE: Surge protector
Output dry contact	2-way, <3A



www.ensmartpower.com

UNITED KINGDOM

Unit 25 Broadfields Farm, Dunmow Road,
Rayne, CM77 6SA, Essex, UK
T: + 44 20 3808 85 60
E: info@ensmart-ess.co.uk

TURKEY

Halk Cad. No:8/A3, Atasehir,
Istanbul, Turkey 34752, TR
T: +90 216 225 84 66
E: sales@ensmartpower.com

Follow us on



[/ensmartpower](#)



[/ensmart_power](#)



[/ensmartpower](#)



[/ensmartpower](#)